

SWING 2 DG

SWING 2 DG R2F

SWING 2 DG R2BF



CONTROL UNIT
FOR
ONE or TWO OPERATORS
(230V/110V)

SEA S.p.A.

Zona Industriale Sant' Atto - 64100 - Teramo - ITALY

Telephone: + 39 0861 588341 - Fax: + 39 0861 588344

www.seateam.com

INDEX

PRELIMINARY INFORMATION AND PRODUCT DETAILS	4
1 - CONNECTIONS	5
2 - CONNECTIONS ON CN1	
START, PARTIAL START AND STOP BUTTONS, PHOTOCELLS, TIMER	6
10K PHOTOCELLS, «LATCH» BUTTONS, EXTERNAL RECEIVER	7
24VAUX INPUT OPTIONS - LOCKS CONNECTION (MAGNETIC, VERTICAL)	8
3 - CONNECTIONS ON CN2	
MOTOR WIRINGS, COURTESY LIGHT	9
4 - CONNECTIONS ON CN3	
CONTROL UNIT POWER SUPPLY	9
5 - CONNECTIONS ON CN4	
ELECTRIC LOCK CONNECTION, FLASHING LIGHT CONNECTION, BUZZER CONNECTION	10
6 - CONNECTIONS ON CN5	
SAFETY EDGE CONNECTION AND MANAGEMENT	11
7 - CONNECTIONS ON CN6	
LIMIT SWITCH CONNECTION	11
8 - CONNECTIONS ON CN7 and CN8	
ANTENNA CONNECTION ON CN7, DRY CONTACT RELAY CONNECTION ON CN8	12
9 - CONNECTIONS ON EXP - EXTERNAL MODULES	
«SEM2» CIRCUIT, «LSE»/«LE» CIRCUIT,	12
«POSITION GATE» POTENTIOMETER CONNECTION AND MANAGEMENT	13
10 - RECEIVERS CONNECTION ON CNS - CNA - CNI	
PLUG-IN RECEIVERS CONNECTION	15
11 - ADDITIONAL FUNCTIONS OF THE CONTROL UNIT	
«SURGE PROTECTOR» CIRCUIT CONNECTION	15

INDEX

12 - DISPLAY OPERATION AND PROGRAMMING MENU	
UNIT SWITCHING ON, DISPLAY READING, BASIC MENU AND SPECIAL MENU	16
13 - BASIC MENU	
BASIC MENU DIAGRAM AND OPERATION	17
14 - INPUTS STATUS MANAGEMENT	
READING OF THE <i>N.C.</i> OR <i>N.O.</i> STATUS OF THE INPUTS ON THE DISPLAY	18
DIAGRAM AND OPERATION OF THE INPUTS MANAGEMENT MENU	19
15 - WORKING TIMES LEARNING - PROGRAMMING OF THE CONTROL UNIT	
TIMES LEARNING WITH LIMIT SWITCH, WITH POTENTIOMETER, BY PULSES DETECTION	20
TIMES LEARNING BY PULSES DETECTION (WITHOUT POTENTIOMETER), PROCEDURE	21
16 - OPERATING LOGICS	
SEMI-AUTOMATIC, AUTOMATIC, SAFETY, STEP-BY-STEP 1 AND 2, DEAD MAN, 2 BUTTONS	22
17 - PASSWORD - PROTECTION OF THE CONTROL UNIT BY PASSWORD	
PASSWORD ENTRY PROCEDURE	22
18 - RECEIVERS AND TRANSMITTERS - PROGRAMMING OF THE TX	
«ROLLING CODE», «ROLLING CODE PLUS», «UNI», «FIX CODE» TRANSMITTERS	23
DIAGRAM OF THE AVAILABLE FUNCTIONS FOR TRANSMITTERS	24
19 - ALARMS AND FAULTS WARNINGS - VIA DISPLAY OR FLASHING LIGHT	
LIST OF FAULTS SHOWN ON THE DISPLAY	25
LIST OF FAULTS INDICATED BY FLASHING LIGHT, DIAGNOSTICS MENU	26
20 - TROUBLESHOOTING	
MOST FREQUENT PROBLEMS AND SOLUTIONS	27
MENU TABLE	29

PRELIMINARY

● **THE SWING 2 DG CONTROL UNIT REQUIRES THE PROGRAMMING OF THE WORKING TIMES (SEE CHAPTER 15); IT IS NOT POSSIBLE TO START THE OPERATOR CORRECTLY WITHOUT FIRST PROGRAMMING THE CONTROL UNIT!**

● THE UNIT AND THE ACCESSORIES PROGRAMMING AND SETTINGS CAN BE CARRY OUT BY THE DISPLAY ON BOARD OR BY THE **JOLLY 3** PROGRAMMER OR **SEACLOUD**



JOLLY 3



SEACLOUD

● FUNCTIONS AND MENUS HERE DESCRIBED ARE VALID ONLY FOR THE BELOW LISTED SOFTWARE REVISIONS; IF SOME FUNCTIONS OR MENUS DO NOT CORRESPOND ON YOUR CONTROL UNIT, CONSULT THE PREVIOUS MANUALS

MODEL	SOFTWARE REVISION
SWING 2 DG R2F	03.01
SWING 2 DG R2BF	00.02



ALL CONNECTIONS (ACCESSORIES, CIRCUITS OR EXTERNAL UNITS) MUST BE MADE WHEN THE CONTROL UNIT IS OFF AND NOT POWERED; ONLY AFTER ALL WIRINGS ARE COMPLETE THE CONTROL UNIT CAN BE SWITCHED ON AND PROGRAMMED

TECHNICAL INFORMATION



POWER SUPPLY	ABSORPTION IN STAND-BY	OPERATING TEMPERATURE	PROTECTION CLASS OF THE PLASTIC BOX (IF INCLUDED)
230VAc - 50/60 Hz OR 115VAc - 50/60 Hz	30 mA	-20° C / +50° C	IP 55

QUICK START

- MAKE ALL CONNECTIONS (**CONTROL UNIT OFF**): ACCESSORIES, MOTORS AND POWER CABLES
- DO NOT JUMPER THE N.C. CONTACTS (**AUTOMATIC DETECTION OF THE N.C. CONTACTS NOT IN USE**)
- POWER ON THE CONTROL UNIT AND CHECK THE CORRECT STATUS OF THE INPUTS (**CHAPTER 14**)
- OPTIONAL - SET UP THE «START» COMMAND ON THE TRANSMITTER (**CHAPTER 18**)
- SET A PAUSE TIME TO OPERATE IN «AUTOMATIC» LOGIC - **CHAPTER 16** - OTHERWISE THE LOGIC WILL BE «SEMI-AUTOMATIC» (AUTOMATIC RECLOSING DISABLED)
- CHOOSE THE MOTOR TYPE ON MENU 3 (**SEE THE MENU TABLE**)

7
 TIMER TO
 CLOSE

3
 MOTOR

● MOVE THE OPERATOR USING THE MENUS 192
MOVE
GATE 1 OR 193
MOVE
GATE 2 ; IF THE GATE OPENS BY PRESSING  AND IF THE GATE CLOSES BY PRESSING  , THE MOTOR RUNS CORRECTLY, OTHERWISE SWAP THE MOTOR CABLES

● START THE WORKING TIMES LEARNING BY FOLLOWING THE PROCEDURE IN **CHAPTER 15**

1 - CONNECTIONS



WARNING: CONNECT ALL DEVICES WHEN THE CONTROL UNIT IS SWITCHED-OFF

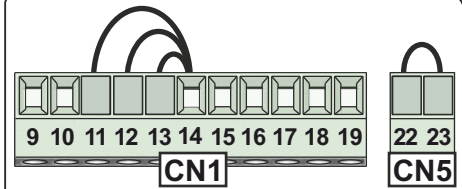
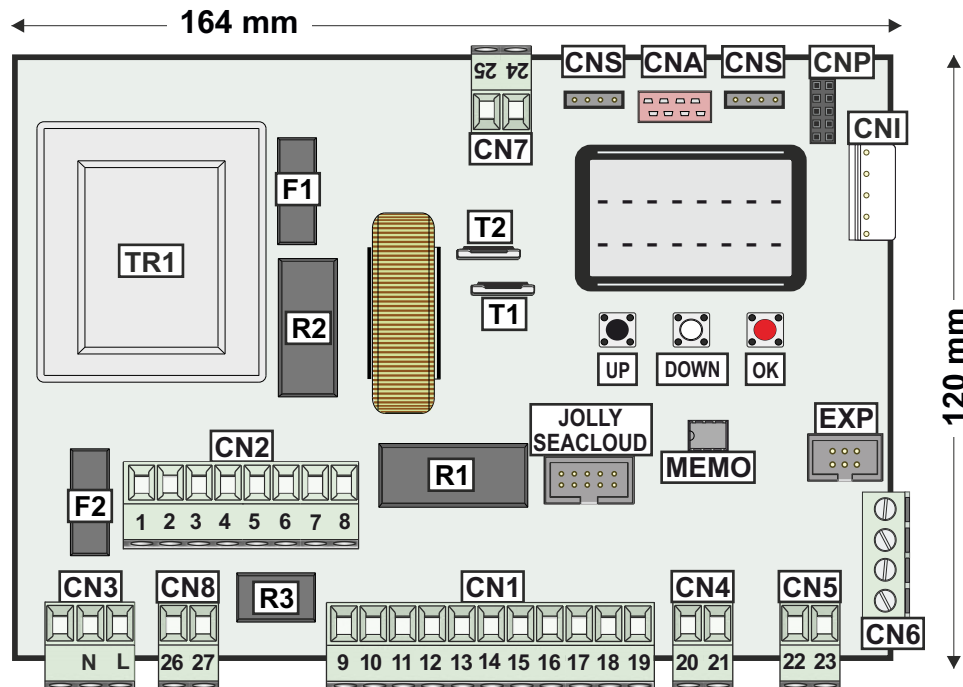

OPTIONAL JUMPERS

● AUTOMATIC RECOGNITION OF THE N.C. INPUTS NOT IN USE - NO JUMPER IS REQUIRED ON THE N.C. CONTACTS

● THE INPUTS EXCLUDED DURING THE WORKING TIMES PROGRAMMING CAN BE RESTORED THROUGH THE «INPUTS MANAGEMENT» MENU (CHAPTER 14). NO NEED TO SET UP THE UNIT AGAIN

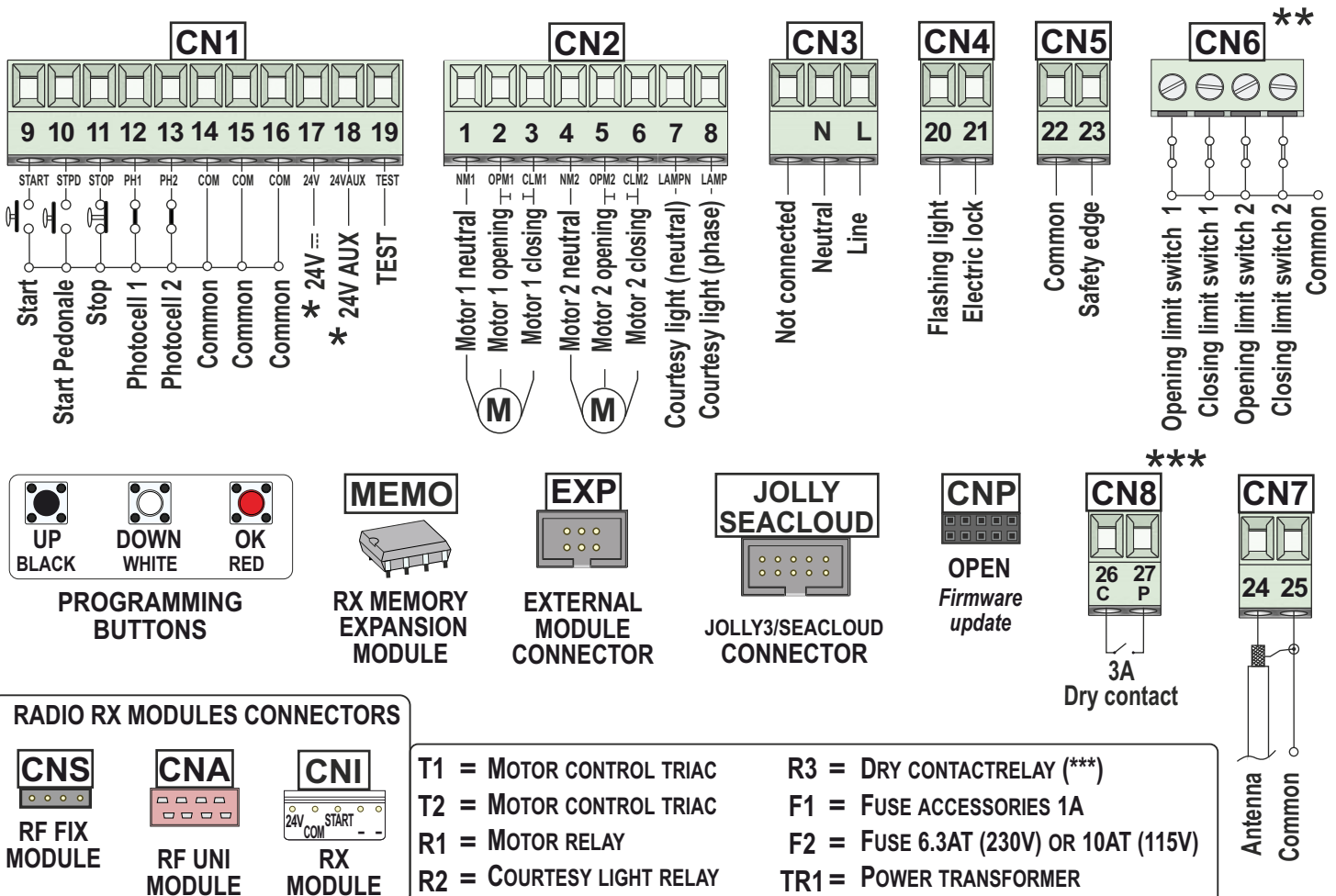

* ALL THE 24V INPUTS SUPPORT A MAXIMUM LOAD OF 500mA, REFERRED TO THE SUM OF THE LOADS OF ALL 24V ACCESSORIES CONNECTED, INCLUDING THE ABSORPTION OF THE RECEIVER ON BOARD (30 mA)

** THE CN6 CONNECTOR IS BUILT ONLY ON THE MODEL SWING 2 DG R2F «FC» WITH LIMIT SWITCH MANAGEMENT

*** THE DRY CONTACT CONNECTOR CN8 SUPPORTS A MAXIMUM LOAD OF 3A AND 250V; IT IS AVAILABLE ONLY ON THE R2 DRY CONTACT HARDWARE VERSION AND WITH ADDITIONAL RELAY

2 - CONNECTIONS ON CN1

2.1 - START (N.O.)

- CONNECT THE «START» ON CLAMPS 9 AND 14 (OR 15 OR 16)
- FOR THE LOGICS TO BE LINKED TO THE «START» COMMAND, SEE THE **CHAPTER 16 (LOGICS)**
- ⇒ IF THE INPUT IS ENGAGED DURING THE PAUSE TIME, THE GATE DOES NOT CLOSE UNTIL THE INPUT IS RELEASED

2.2 - PARTIAL START (N.O.)

- CONNECT THE «PARTIAL START» ON 10 AND 14 (OR 15 OR 16)
- FOR THE LOGICS TO BE LINKED TO THE «START» COMMAND, SEE THE **CHAPTER 16 (LOGICS)**
- PARTIAL OPENING SPACE MANAGEMENT: **90 PARTIAL OPENING**
- PARTIAL OPENING PAUSE TIME MANAGEMENT: **91 PARTIAL PAUSE**
- ⇒ IF THE INPUT IS ENGAGED DURING THE PAUSE TIME, THE GATE DOES NOT CLOSE UNTIL THE INPUT IS RELEASED

- ⓘ IF YOU CONNECT A TRAFFIC LIGHT VIA THE **SEM2** MANAGEMENT UNIT (SEE PARAGRAPH 9.1) IT IS POSSIBLE TO ACTIVATE THE PRIORITY IN OPENING OR CLOSING ASSOCIATED TO THE «START» OR «PARTIAL START» COMMANDS, VIA MENU **89 TRAFFIC LIGHT RESERVATION**

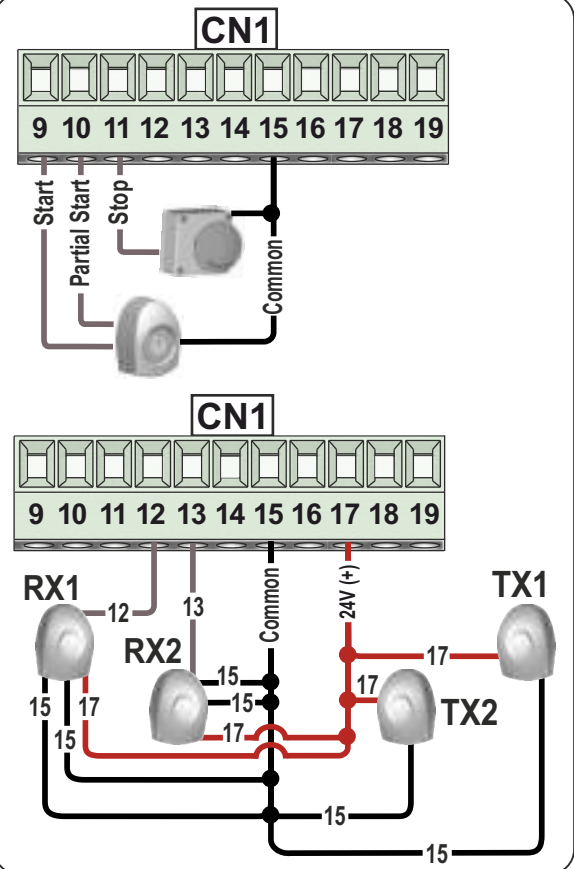

2.3 - STOP (N.C.)

- CONNECT THE «STOP» COMMAND BUTTON ON CLAMPS ON CLAMPS 11 AND 14 (OR 15 OR 16)
- AFTER STOPPING, PRESS «START» TO RESTORE THE MOVEMENT (AFTER A «STOP» COMMAND, THE OPERATOR ALWAYS RESTARTS CLOSING)

2.4 - PHOTOCELL 1 AND PHOTOCELL 2 (N.C.)

- CONNECTIONS: **+ = 24V $\overline{\text{---}}$ MAX 500mA (CLAMP 17)** **COM = 0V (CLAMPS 14 - 15 - 16)**
PH1 = PHOTOCELL 1 (CLAMP 12) **PH2 = PHOTOCELL 2 (CLAMP 13)**
- MANAGEMENT: **97 PHOTOCELL 1** **98 PHOTOCELL 2**
- «PHOTOTEST» FUNCTION: CONNECT THE Tx-PHOTOCELL NEGATIVE CABLE ON CLAMP 19 «TEST» AND CHOOSE WHICH PHOTOCELL TO TEST AMONG THE OPTIONS OF MENU **95 PHOTOTEST**
- ⇒ **DEFAULT SETTINGS: MENU 97 = «CLOSING»; MENU 98 = «OPENING AND CLOSING»**

- ⓘ **TO SAVE ENERGY IN STAND-BY CONNECT THE PHOTOCELL POWER SUPPLY CABLE TO THE TERMINAL 18 (AUX) AND SET THE MENU 94 TO «IN CYCLE»**

2.5 - TIMER (N.O.) - EXTERNAL CLOCK

- CONNECT THE TIMER TO THE CLAMP 10 «PARTIAL START» OR TO THE 13 «PHOTOCELL 2» **92 TIMER**
- IF CONNECTED ON THE «PARTIAL START», THIS COMMAND WILL BE DISABLED (ON TRANSMITTERS TOO)
- THE TIMER OPENS AND KEEPS THE GATE OPEN UNTIL ENGAGED; WHEN RELEASED, THE GATE CLOSING ONLY AFTER THE PRE-SET PAUSE TIME HAS ELAPSED.
- IN THE EVENT OF A SAFETY ACCESSORY INTERVENTION, THE TIMER RESETS AUTOMATICALLY AFTER 6 SEC.
- ⇒ **IN THE EVENT OF A POWER FAILURE WHEN THE GATE IS OPEN: IF THE TIMER IS STILL ACTIVE WHEN THE POWER IS RESTORED, THE GATE REMAINS OPEN IF THE TIMER IS NO LONGER ACTIVE, A «START» INPUT WILL BE REQUIRED TO CLOSE THE GATE**

2.6 - 10K PHOTOCELL SINGLE OR DOUBLE

10K PHOTOCELLS - ONLY ON MODEL «SWING 2 DG R2BF»

● CONNECT PHOTOCELLS ON CLAMPS 12 - 14 - 17 and 13 - 14 - 17
 ⇨ INSTEAD OF CLAMP 14 YOU CAN USE THE OTHER TWO «COM» INPUTS ON CLAMPS 15 OR 16

● ONE OR TWO 10K PHOTOCELLS CAN BE CONNECTED; SET THE MENUS 121 OR 122 ON «10K PHOTOCELL»

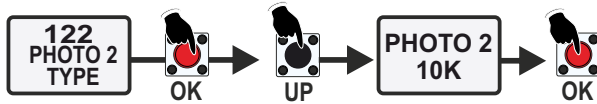
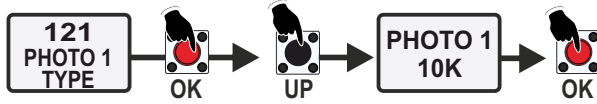

EXAMPLE OF 10K PHOTOCELLS CONNECTION

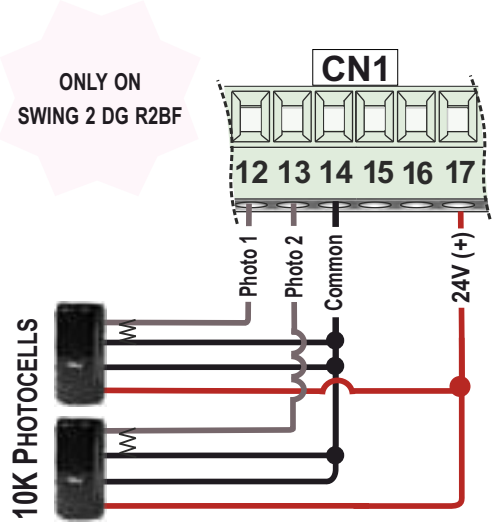

● IT IS POSSIBLE TO SET THE DESIRED OPERATION MODE VIA «PHOTOCELL» MENUS

⇨ BY THE USE OF THE 10K PHOTOCELLS, A FURTHER PROTECTION IS GIVEN, EVEN IN THE EVENT OF A SHORT-CIRCUIT ON THE CABLES

97
PHOTOCELL
1

98
PHOTOCELL
2

2.7 - LATCH OPENING OR LATCH CLOSING BUTTON

● CONNECT ON CLAMPS 10 AND 14 (OR 15 OR 16)

⚠ THE «PARTIAL START» FUNCTION WILL BE DISABLED

● MANAGEMENT: SET THE DESIRED OPERATION MODE ON MENU 118

● TO DISABLE THE LATCH FUNCTION, PRESS AGAIN THE ACTIVATION COMMAND

⇨ THE LATCH FUNCTION CAN BE ALSO ENABLED ON THE SECOND CHANNEL OF THE TRANSMITTER; SEE THE **PARAGRAPH 18.4** FOR MORE DETAILS

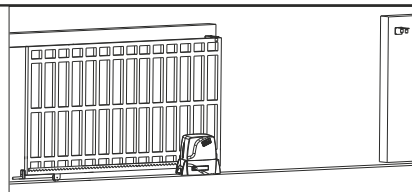
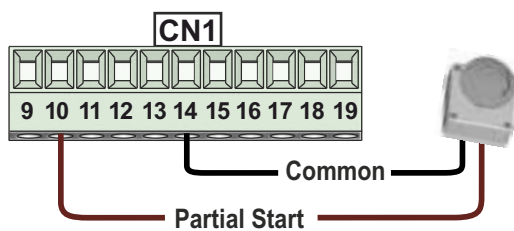
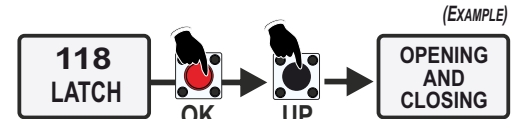

LATCH OPENING
OPENS AND KEEPS OPEN

NO COMMAND ACCEPTED

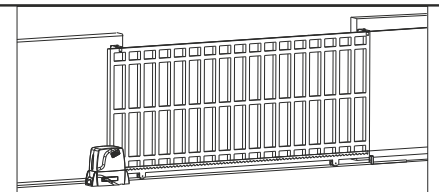

LATCH CLOSING
CLOSES AND KEEPS CLOSED

NO COMMAND ACCEPTED

2.8 - EXTERNAL RECEIVER

● AN EXTERNAL RECEIVER CAN BE CONNECTED ACCORDING TO THE CONNECTION DIAGRAM ON THE SIDE.

● FOR THE OPERATION OF THE RECEIVER, REFER TO ITS INSTRUCTION MANUAL

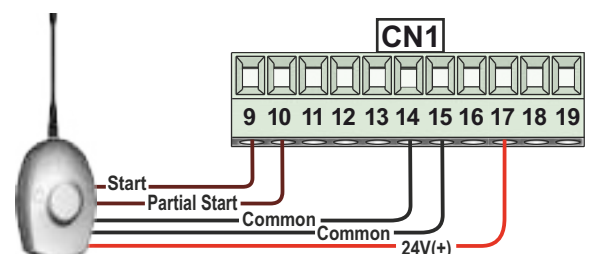

2.9 - 24V \rightleftharpoons DC AUX INPUT OPTIONS - CLAMP 10 - MAX 500mA

- MANAGEMENT: ON MENU 94 CHOOSE HOW TO HAVE VOLTAGE ON THE AUX INPUT, ACCORDING TO THE TYPE OF ACCESSORY YOU CONNECT

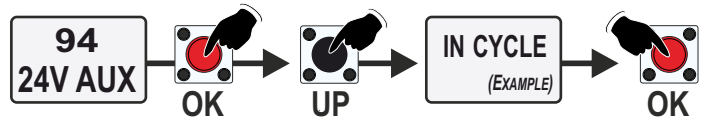

CONNECT THE ACCESSORY ONLY AFTER SETTING THE MENU 94 ON THE DESIRED OPTION!

- A RELAY CAN BE CONNECTED TO THE 24VAUX INPUT; THE RELAY ALLOWS THE CONNECTION AND THE MANAGEMENT OF ADDITIONAL ACCESSORIES (*COURTESY LIGHT, LOCKS ETC.*); SOME EXAMPLES BELOW, INCLUDING THE MENU 94 SETTINGS

MAGNETIC OR VERTICAL LOCK CONNECTION - BY THE USE OF TWO DIFFERENT RELAY MODELS

- TO USE THE MAGNETIC LOCK OR VERTICAL LOCK SET THE MENU 94 ON «**NEGATIVE BRAKE MANAGEMENT**» (24VAUX INPUT POWERED DURING THE CYCLE AND 1 SECOND BEFORE STARTING)

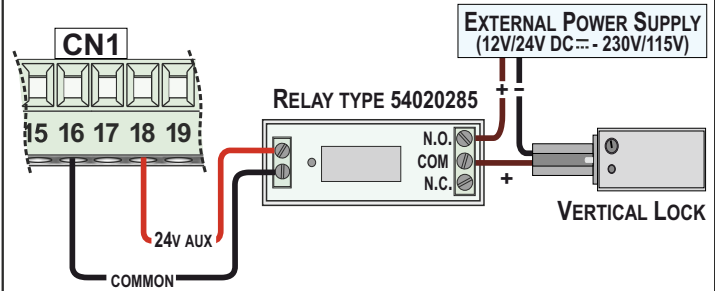
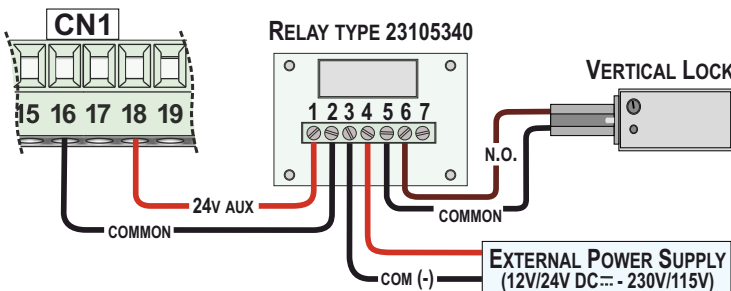
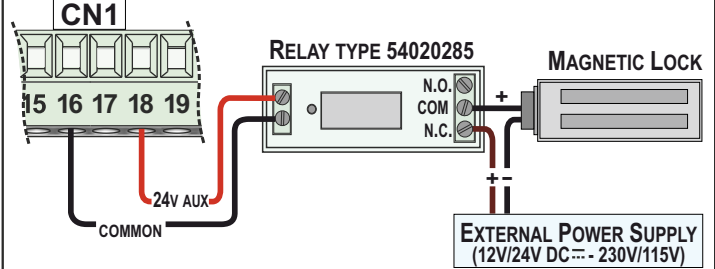
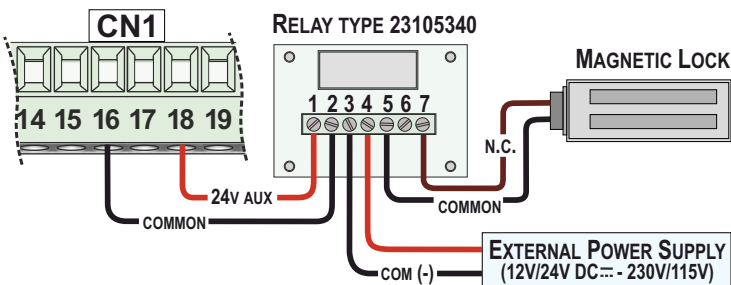
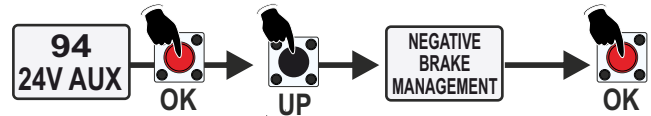

THE «**PUSHING STROKE**» OPTION SIMPLIFIES THE LOCK RELEASE BY GIVING A LITTLE PUSHING STROKE BEFORE STARTING MOVEMENT

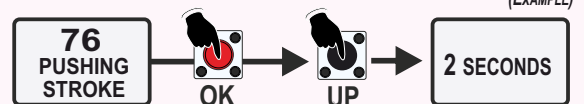

3 - CONNECTION ON CN2

3.1 - MOTOR CONNECTION ON THE CONTROL UNIT

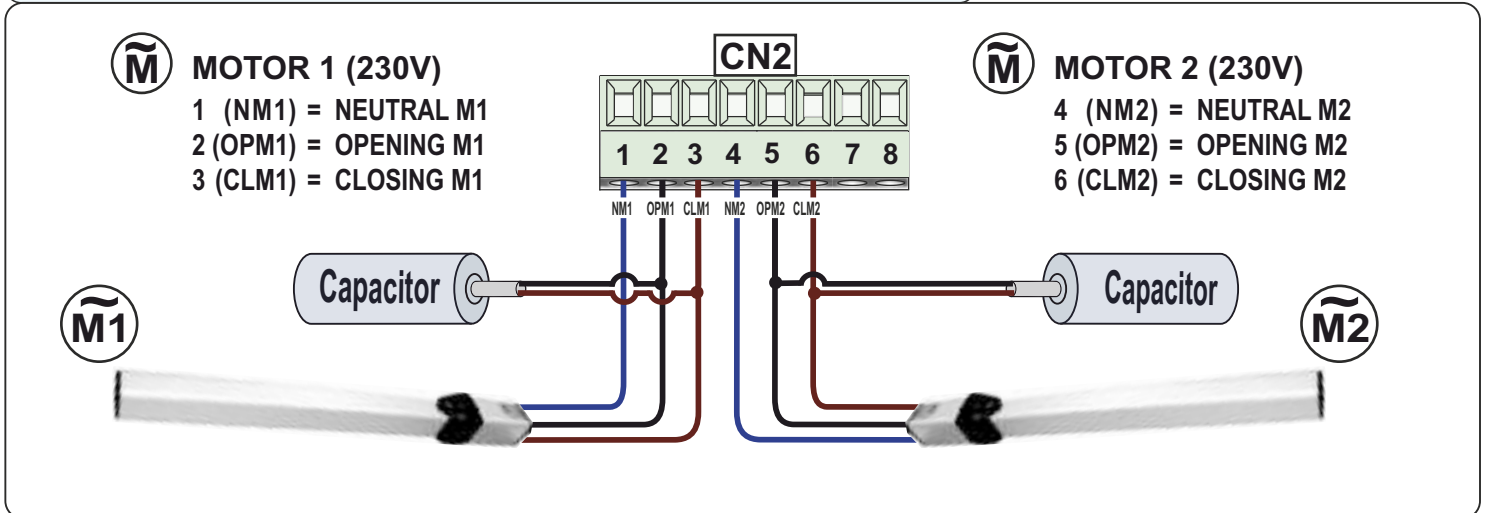

➔ IN THE CASE OF A SINGLE LEAF, CONNECT THE OPERATOR AS MOTOR 1; IF NECESSARY, ADJUST THE MENUS PARAMETERS FOR M1 ONLY

3.2 - COURTESY LIGHT CONNECTION

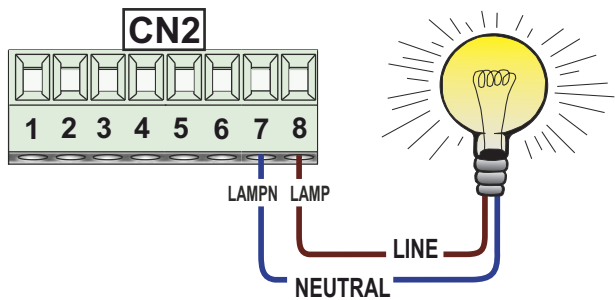

⚠ Max. 50W → 230V Max. 100W → 115V

● COURTESY LIGHT OR FLASHING LIGHT CONNECTION OPERATING VIA FLASHING BOARD

● MANAGEMENT: MENU 88

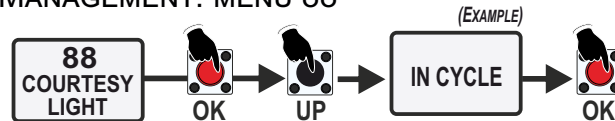

i IF THE COURTESY LIGHT IS CONNECTED VIA SEM MANAGEMENT UNIT (**PARAGRAPH 9.1**), THEN IT IS POSSIBLE TO SET THE TIMING FROM 1 TO 240 SECONDS VIA MENU 88

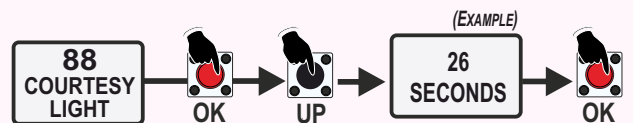

4 - POWER SUPPLY CONNECTION ON CN3

4.1 - CONTROL UNIT POWER SUPPLY

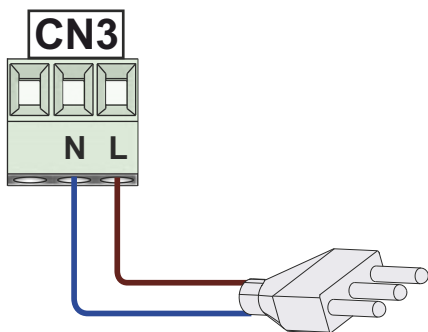

- FUSE 16AT DELAYED ON 230V~ POWER SUPPLY
FUSE 16AT DELAYED ON 115V~ POWER SUPPLY
- USE A 10A DIFFERENTIAL SWITCH TO PROTECT THE POWER SUPPLY SYSTEM
- IN CASE OF UNSTABLE POWER SUPPLY, THE USE OF AN EXTERNAL UPS OF MIN.800VA IS RECOMMENDED

⚠ FOR THE CONNECTION TO THE POWER GRID RESPECT THE LAWS IN FORCE

⚠ THE CONTROL UNIT MUST BE POWERED ONLY AFTER ALL THE WIRINGS HAVE BEEN COMPLETED!

5 - CONNECTION ON CN4

5.1 - COLLEGAMENTO ELETTROSERRATURA 12V - 3A max

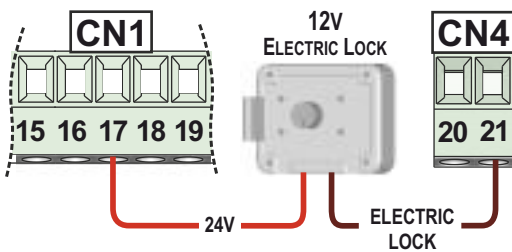

- CONNECT A 12V AND MAX 15W ELECTRIC LOCK
- TO ADJUST THE RELEASE TIME OF THE LOCK USE THE MENU 77

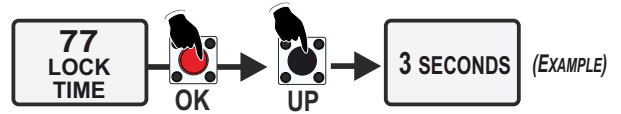

- TO CHOOSE THE LOCK ACTIVATION MODE USE THE MENU 78

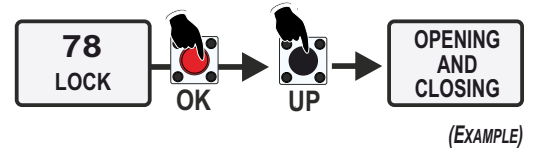

i THE «PUSHING STROKE» OPTION SIMPLIFIES THE LOCK RELEASE BY GIVING A LITTLE PUSHING STROKE BEFORE STARTING MOVEMENT

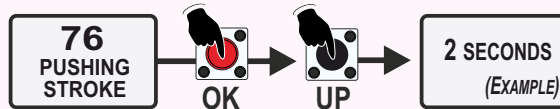

5.2 - 24V $\overline{\text{=}}$ FLASHING LIGHT - MAX 3W

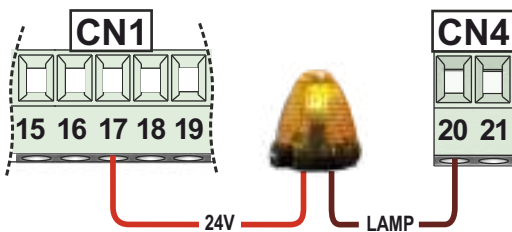

- CONNECT A 24V AND MAX 4W FLASHING LIGHT
- GATE MOVEMENT SIGNALS:
1 BLINK/SECOND IN OPENING
2 BLINKS/SECOND IN CLOSING
STEADY LIT DURING PAUSE

⇒ THE CONTROL UNIT SENDS THE WARNING SIGNALS THROUGH THE FLASHING LAMP; SEE **CHAPTER 19**

- MANAGEMENT: MENU 86 **86 FLASHING LIGHT**
- PRE-FLASHING FUNCTION: MENU 85 **85 PRE-FLASHING**

5.3 - 24V $\overline{\text{=}}$ and MAX 100 dB BUZZER

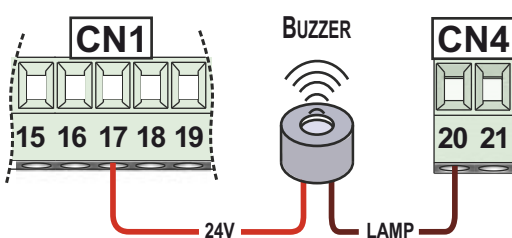

- USE A 24V $\overline{\text{=}}$ AND 100 dB OSCILLATING BUZZER
- BUZZER CAN BE CONNECTED INSTEAD OF THE FLASHING LIGHT; **HOWEVER, IT IS NECESSARY TO SET THE MENU AS «BUZZER»**

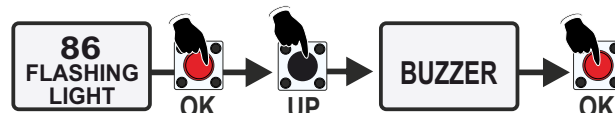

- THE BUZZER ACTIVATES AFTER 2 CONSECUTIVE INTERVENTIONS OF THE ANTI-CRUSHING PROTECTION

⇒ PRESS THE STOP BUTTON TO TURN OFF THE BUZZER; ANYWAY, THE SOUND SWITCHES OFF AUTOMATICALLY AFTER 5 MINUTES AND THE OPERATOR REMAINS STOPPED WAITING FOR A NEW COMMAND

6 - CONNECTION ON CN5

6.1 - SAFETY EDGE (N.C.)

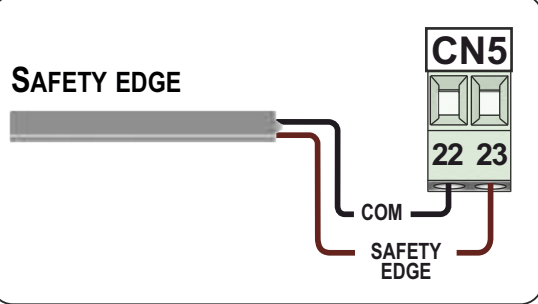

● CHOICE OF THE SAFETY EDGE TYPE: MENU 100

100
SAFETY
EDGE 1

● DIRECTION MANAGEMENT:
MENU 102 (MENU 103*)

102
EDGE 1
DIRECTION

103*
EDGE 2
DIRECTION

i A SECOND SAFETY EDGE (NORMAL TYPE) CAN BE CONNECTED TO THE «PHOTOCELL 2» INPUT AND CAN BE ACTIVATED BY SETTING MENU 98 TO «SAFETY EDGE 2»

*** THE DIRECTION OF THIS SECOND SAFETY EDGE CAN BE MANAGED FROM MENU 103**

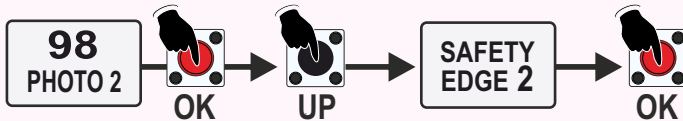

⇒ **BALANCED OR 8K2 RESISTIVE SAFETY EDGE OPTION: WIRING CONTROL THROUGH RESISTANCE VALUE FOR THE SHORT-CIRCUITS DETECTION (WITH ALARM ON DISPLAY)**

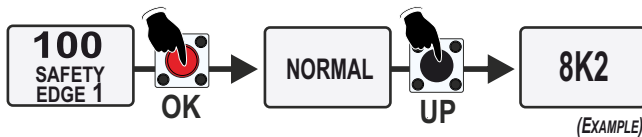

ON MODEL «R2F»: MANAGEMENT OF A SINGLE SAFETY EDGE (N.C.) - BALANCED AND WITH 8K2 RESISTANCE

ON MODEL «R2BF»: MANAGEMENT OF A SINGLE SAFETY EDGE (N.C.) - BALANCED AND WITH 8K2 RESISTANCE OR OF A SINGLE 8K2 PURE RESISTIVE SAFETY EDGE

7 - CONNECTION ON CN6

7.1 - LIMIT SWITCH CONNECTION - ON «FC» VERSION ONLY

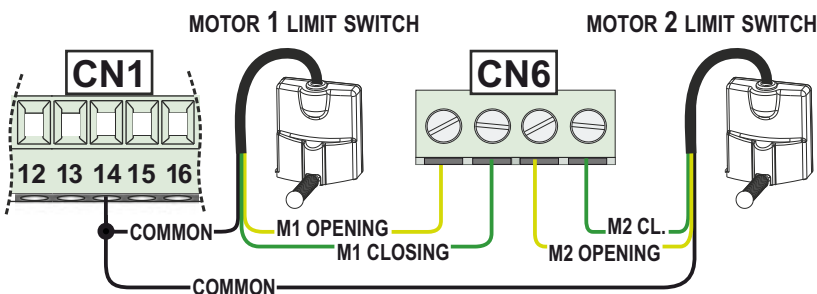

● CONNECT THE OPENING AND CLOSING LIMIT SWITCHES OF THE FIRST AND THE SECOND OPERATOR AS SHOWN ON THE SIDE

⇒ THE TYPE OF LIMIT SWITCH IS AUTOMATICALLY DETECTED DURING THE WORKING TIMES LEARNING

i ANTI-INTRUSION FUNCTION:

IT IS LINKED TO THE PRESENCE OF ONE

LIMIT SWITCH AT LEAST (**OR OF POTENTIOMETER- SEE PARAGRAPH 9.3**); IF ENABLED, THIS FUNCTION RESTORES THE ORIGINAL STATE OF THE GATE AFTER THE MANUAL FORCING

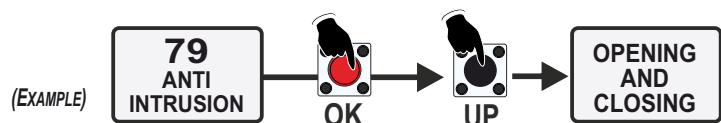

8 - CONNECTION ON CN7 and CN8

8.1 - ANTENNA

- CONNECT THE ANTENNA ACCORDING TO THE WIRING DIAGRAM ASIDE

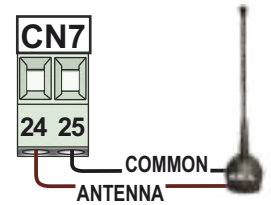

8.2 - DRY CONTACT RELAY



DRY CONTACT RELAY AVAILABLE ONLY ON HARDWARE VERSION
«R2 DRY CONTACT» WITH ADDITIONAL RELAY

- DRY CONTACT RELAY: MAX. 3A AND 250V
- THE RELAY IS FOR GENERAL USE, FOR EXAMPLE IT IS POSSIBLE TO CONNECT A TIMER TO TURN ON A LIGHT
- DEFAULT OPERATION IN «START 3s» MODE: THE RELAY AUTOMATICALLY ACTIVATES AT EACH «START» OR «PARTIAL START» IMPULSE FOR 3 SECONDS OR AT EACH PHOTOCELL INTERVENTION
- ON «R2BF» MODEL: IT IS POSSIBLE TO DISABLE THE «START 3s» OPERATION VIA 132-RELAY MENU AND CHOOSE TO ACTIVATE THE RELAY MANUALLY VIA REMOTE CONTROL (STORING THE RELAY ACTIVATION FUNCTION ON A KEY OF THE TX - PARAGRAPH 19.4)

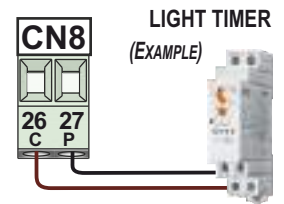

9 - CONNECTION ON EXP

9.1 - «SEM 2» MANAGEMENT UNIT

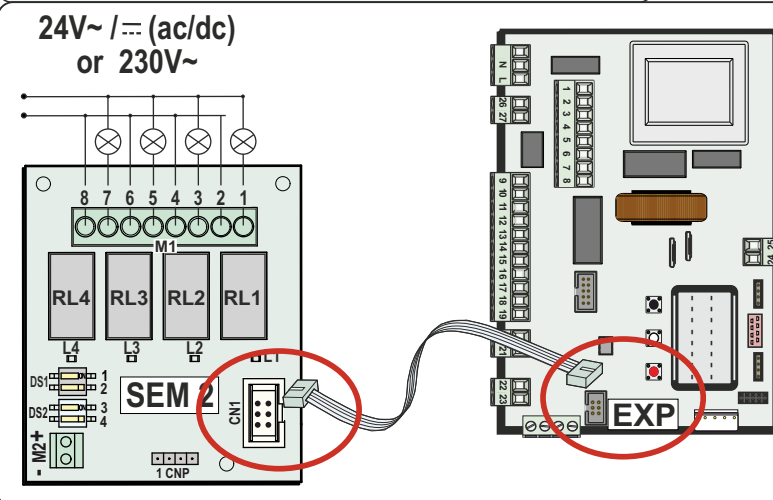

- THE SEM 2 ACCESSORIES MANAGEMENT UNIT ALLOWS YOU TO CONNECT AND MANAGE THE FOLLOWING ADDITIONAL ACCESSORIES:
 - TRAFFIC LIGHT
 - COURTESY LIGHT
 - VERTICAL ELECTRIC LOCK
 - POSITIVE OR NEGATIVE ELECTRIC BRAKE

⇒ SEM2 MANAGES THE STATUS OF THE LIMIT SWITCHES TO ALLOW THE CONNECTION OF ACCESSORIES WHICH ACTIVATION DEPENDS ON THE LIMIT SWITCH STATUS

MORE DETAILS ON SEM 2 INSTRUCTIONS

9.2 - «LSE» or «LE» MANAGEMENT UNITS

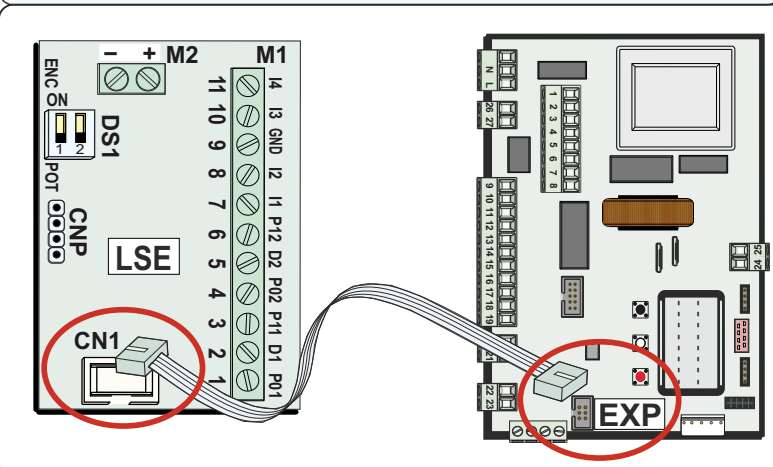

- THE LSE (OR LE) MANAGEMENT CIRCUITS ALLOW YOU TO CONNECT AND MANAGE DIFFERENT ADDITIONAL ACCESSORIES, SUCH AS THE POTENTIOMETER

MORE DETAILS ON LSE (OR LE) INSTRUCTIONS

9.3 - «POSITION GATE» LINEAR POTENTIOMETER CONNECTION VIA «LSE» or «LE»

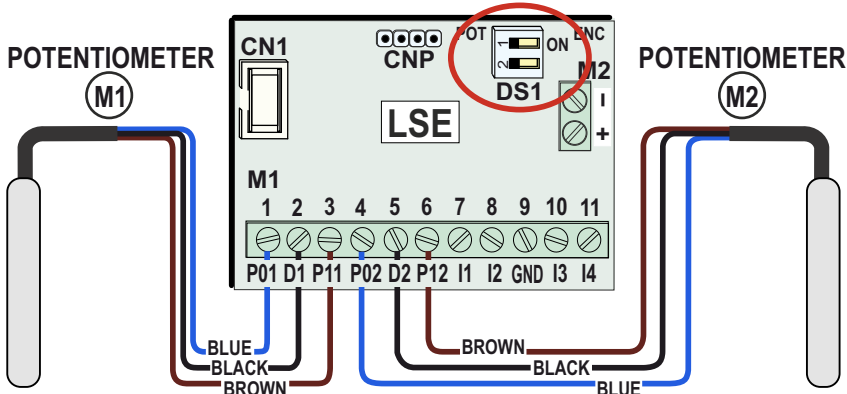

- CONNECT THE «POSITION GATE» LINEAR POTENTIOMETER FOR MANAGING THE CORRECT POSITION OF THE GATE AND THE INVERSION ON OBSTACLES, AS SHOWN ON THE SIDE

- RESPECT THE CABLE COLORS
 OLD MODEL → BROWN - GREEN - WHITE
 NEW MODEL → BROWN - BLUE - BLACK

⚠ ON «DS1» ADJUST BOTH DIP-SWITCHES TO «OFF»

BLUE (GREEN) → P01
 BLACK (WHITE) → D1
 BROWN → P11

BLUE (GREEN) → P02
 BLACK (WHITE) → D2
 BROWN → P12

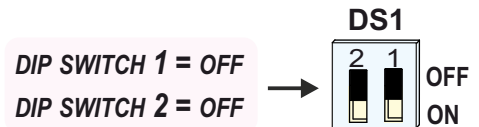

➔ FOR DISTANCES OF MORE THAN 2m, CONNECT A 3-POLE SHIELDED CABLE AND WIRE THE SHIELD ON THE COMMON

- TO ENABLE THE POTENTIOMETER:

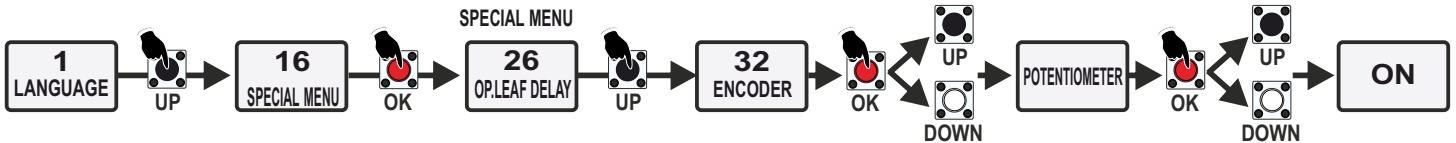

9.4 - POTENTIOMETER SETTINGS

- POTENTIOMETER SUBMENU: MOTOR 1 (MENU 51) OR MOTOR 2 (MENU 54) PARTIAL IMPULSES DISPLAYING THE OPERATOR CURRENT POSITION

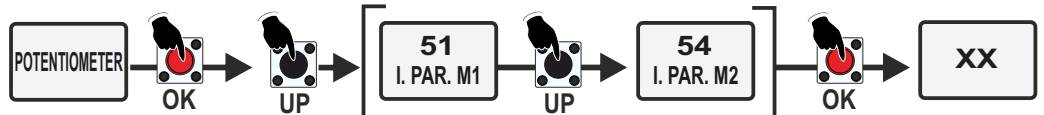

- POTENTIOMETER SUBMENU: MOTOR 1 (MENU 52) OR MOTOR 2 (MENU 55) IMPULSES IN OPENING DISPLAY OF IMPULSES WITH THE LEAF COMPLETELY OPEN; POSSIBILITY OF INCREASING OR DECREASING THE TOTAL PULSES

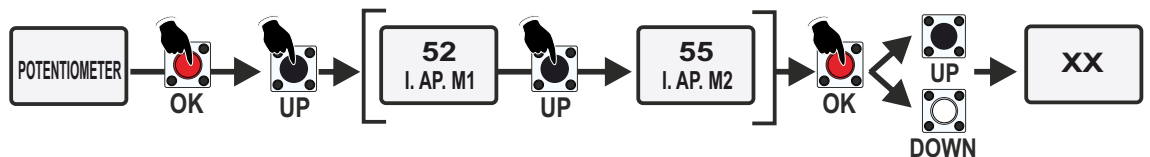

- POTENTIOMETER SUBMENU: MOTOR 1 (MENU 53) OR MOTOR 2 (MENU 56) IMPULSES IN CLOSING DISPLAY OF IMPULSES WITH THE LEAF COMPLETELY CLOSED; POSSIBILITY OF INCREASING OR DECREASING THE TOTAL PULSES

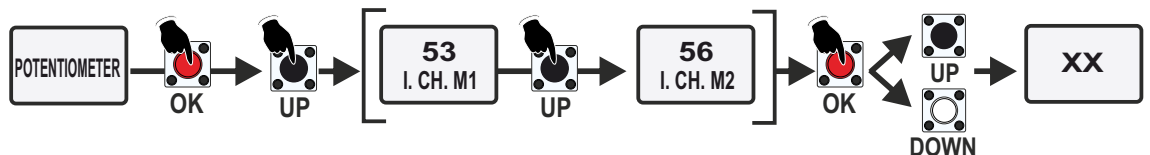

⚠ THE «POTENTIOMETER DIRECTION» ALARM APPEARS ON THE DISPLAY IF THE POTENTIOMETER READING IS INVERTED IN COMPARISON WITH THE DIRECTION OF MOVEMENT (SEE CHAPTER 19); SWAP THE BROWN WIRE WITH THE GREEN (OR BLUE) WIRE AND REPEAT THE PROGRAMMING

9.5 - POTENTIOMETER PARAMETERS ADJUSTMENT

- SENSITIVITY PARAMETERS IN OPENING AND CLOSING (MOTOR 1 AND MOTOR 2) FOR POTENTIOMETER INTERVENTION TIME ADJUSTMENT

⇒ FOR A QUICK REVERSE ON OBSTACLE DECREASE THE SENSITIVITY



SET TO OFF (INTERVENTION EXCLUDED): THE POTENTIOMETER ONLY DETECTS THE IMPULSES (DOES NOT REVERSE ON OBSTACLE)

- SLOWDOWN SENSITIVITY PARAMETER FOR ADJUSTMENT OF THE INVERSION TIME DURING THE SLOW DOWN

⇒ FOR A QUICK REVERSE ON OBSTACLE DECREASE THE SENSITIVITY

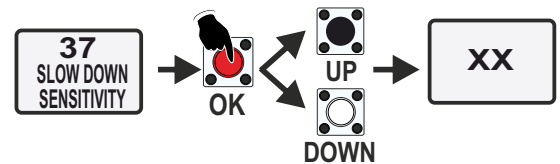

- POTENTIOMETER INTERVENTION THRESHOLD ADJUSTMENT IN OPENING AND CLOSING (MOTOR 1 AND MOTOR 2)

⇒ THE LOWER THE THRESHOLD, THE GREATER THE FORCE REQUIRED FOR THE INVERSION

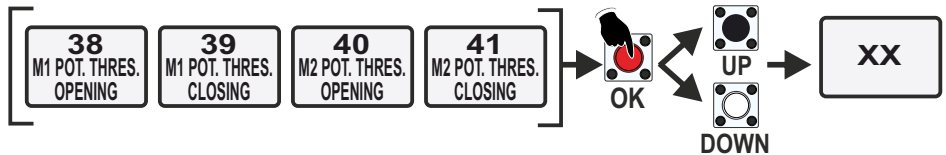

- POTENTIOMETER INTERVENTION THRESHOLD ADJUSTMENT (INTERVENTION DURING THE SLOWDOWN IN OPENING AND SLOWDOWN IN CLOSING (M1 - M2))

⇒ THE LOWER THE THRESHOLD, THE GREATER THE FORCE REQUIRED FOR THE INVERSION

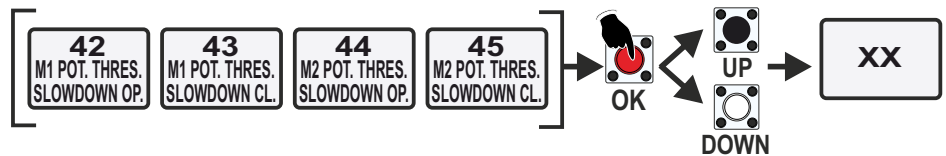

9.6 - ACCESS TO THE HIDDEN «DEBUG» MENU FOR POTENTIOMETER

- TO DISPLAY THE INSTANTANEOUS SPEED VALUES DETECTED «VP1» AND «VP2»; KNOWING THESE VALUES ALLOWS YOU TO ADJUST THE INTERVENTION THRESHOLDS OF THE POTENTIOMETER IN OPENING, CLOSING AND DECELERATION (SEE NEXT PARAGRAPH). **THE THRESHOLDS MUST ALWAYS BE ADJUSTED TO VALUES GREATER THAN THE «VP1» AND «VP2» VALUES**

FOR MORE DETAILS ON THE DISPLAY, SEE CHAPTER 12

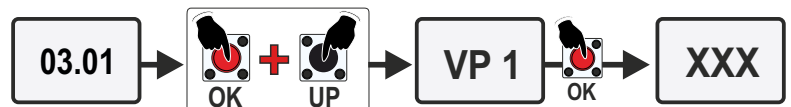

10 - RECEIVERS CONNECTIONS

RF UNI
RF UNI PG

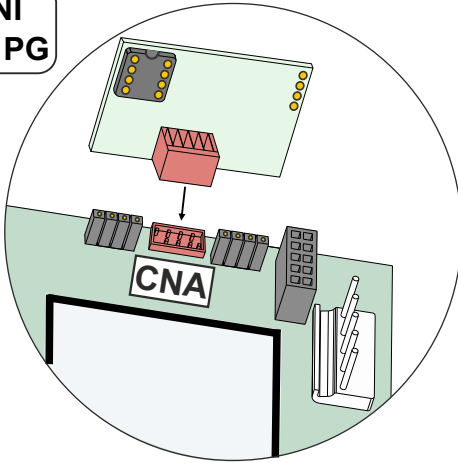

RF FIX

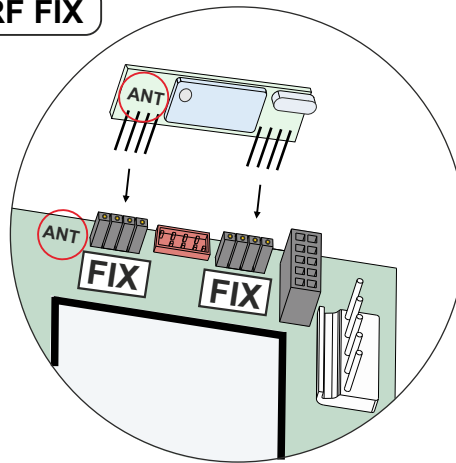

RX MODULE

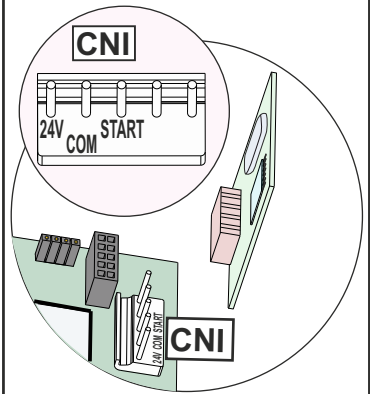

RESPECT THE PLUG-IN DIRECTION OF THE DIFFERENT CIRCUITS;

RF FIX: THE «ANT» CONTACTS PRINTED ON THE RECEIVER AND CONTROL UNIT MUST MATCH

RX MODULE: THE «24V» «COM» AND «START» CONTACTS ON THE RECEIVER AND CONTROL UNIT MUST MATCH

11 - ADDITIONAL FUNCTIONS

11.1 - «I/O SURGE PROTECTOR» CIRCUIT CONNECTION

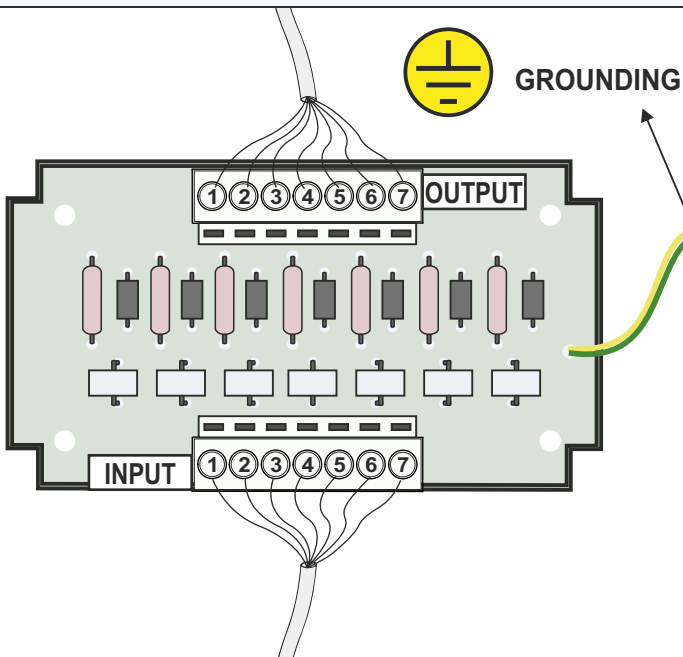

OUTPUT CONNECTION ON CONTROL UNIT

- | | |
|---|-----------------------------|
| 1 | 24V DC ACCESSORIES |
| 2 | CONTACT 1 (Es. PHOTOCCELL) |
| 3 | CONTACT 2 (Es. SAFETY EDGE) |
| 4 | CONTACT 3 (Es. START) |
| 5 | CONTACT 4 |
| 6 | CONTACT 5 |
| 7 | CONTACT 6 |

INPUT ACCESSORIES CONNECTION

- | | |
|---|-----------------------------|
| 1 | 24V DC ACCESSORIES |
| 2 | CONTACT 1 (Es. PHOTOCCELL) |
| 3 | CONTACT 2 (Es. SAFETY EDGE) |
| 4 | CONTACT 3 (Es. START) |
| 5 | CONTACT 4 |
| 6 | CONTACT 5 |
| 7 | CONTACT 6 |

● To PROTECT UP TO 6 INPUTS AND THE 24V POWER SUPPLY FROM TEMPORARY OVERLOADS
(ES. LIGHTNING STRIKES)

● CONNECT THE 24VDC CABLE AND THE ACCESSORIES CABLES ON **INPUT**; CONNECT THE CORRESPONDING CABLES FROM **OUTPUT** TO THE CONTROL UNIT



CONNECT THE NEGATIVE AND THE COMMON CABLES FROM THE MAIN POWER SUPPLY TO THE CONTROL UNIT

12 - DISPLAY and PROGRAMMING



**CONNECT ALL THE ACCESSORIES WHEN THE CONTROL UNIT IS SWITCHED OFF!
AFTER ALL CONNECTIONS HAVE BEEN MADE, POWER ON THE UNIT FOR SETTINGS**

12.1 - OLD and NEW DISPLAY

DISPLAY ON MODEL «R2F»

MENU	SEA	SET
---	---	---
---	---	---

IN THE OLD TYPE DISPLAY THE INPUTS ARE REPRESENTED BY **OFF** OR **ON** DASHES DEPENDING ON WHETHER THE CORRESPONDING CONTACT IS OPEN OR CLOSED

DISPLAY ON MODEL «R2BF»

00111110
11110000

IN THE NEW BINGO DISPLAY THE INPUTS ARE REPRESENTED BY THE SYMBOLS «0» AND «1» DEPENDING ON WHETHER THE CORRESPONDING CONTACT IS OPEN (0) OR CLOSED (1)

➔ **ALL OTHER SCREENS AND VIEWS ARE IDENTICAL IN THE TWO DISPLAYS**

12.2 - POWER ON THE CONTROL UNIT

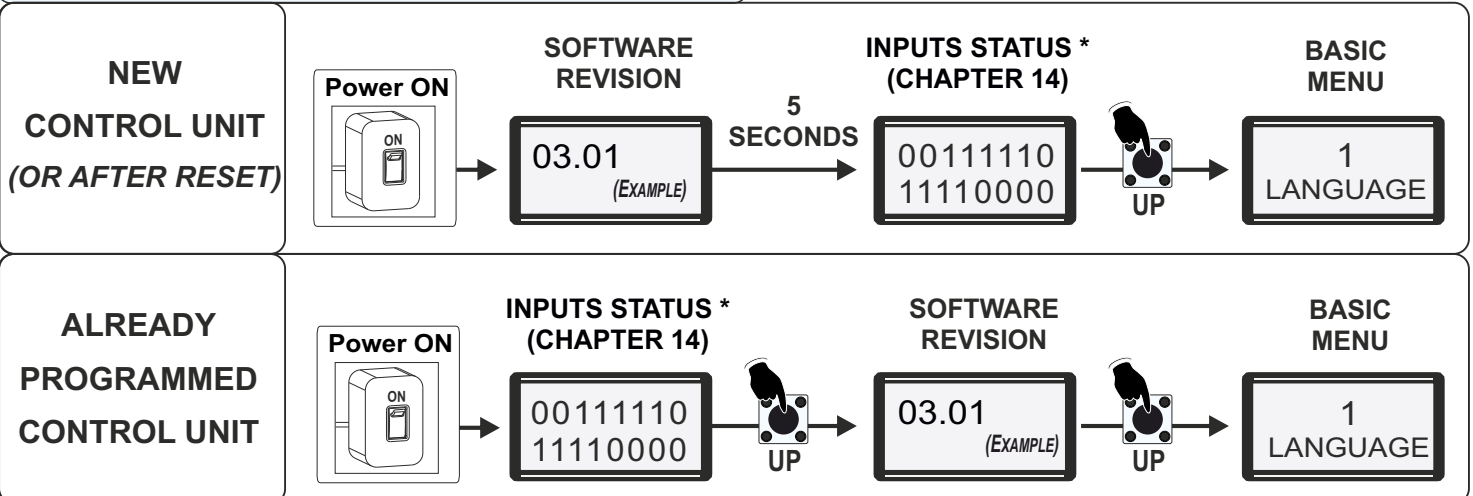

* ON THE «R2F» MODEL, THE DISPLAY OF THE INPUTS WILL BE REPRESENTED WITH DASHES

12.3 - BASIC MENU and SPECIAL MENU

- THE CONTROL UNIT HAS A **BASIC MENU** (CHAPTER 13) WHICH ALLOWS THE BASIC SETTINGS IN ORDER TO START USING THE PRODUCT QUICKLY
- THE **SPECIAL MENU** ALLOWS TO CHANGE DEFAULT SETTINGS, OR TO ENABLE/DISABLE THE ACCESSORIES OR THE CONTROL UNIT FUNCTIONS
- TO ACCESS THE **SPECIAL MENU** USE ONE OF THE TWO FOLLOWING METHODS

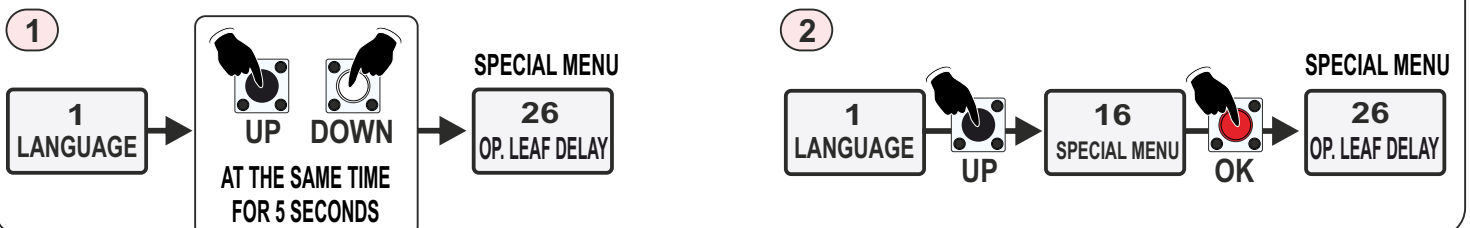

➔ IN THE **BASIC MENU** IT IS POSSIBLE TO **SELECT THE MODEL OF OPERATOR** IN USE AND OTHER NECESSARY OPTIONS. ONCE THE MODEL HAS BEEN CHOSEN, ALL THE SPECIAL MENUS ARE AUTOMATICALLY SET TO THE DEFAULT VALUES USEFUL FOR THE SELECTED OPERATOR, SO FURTHER SETTINGS MAY NOT BE NECESSARY

13 - BASIC MENU

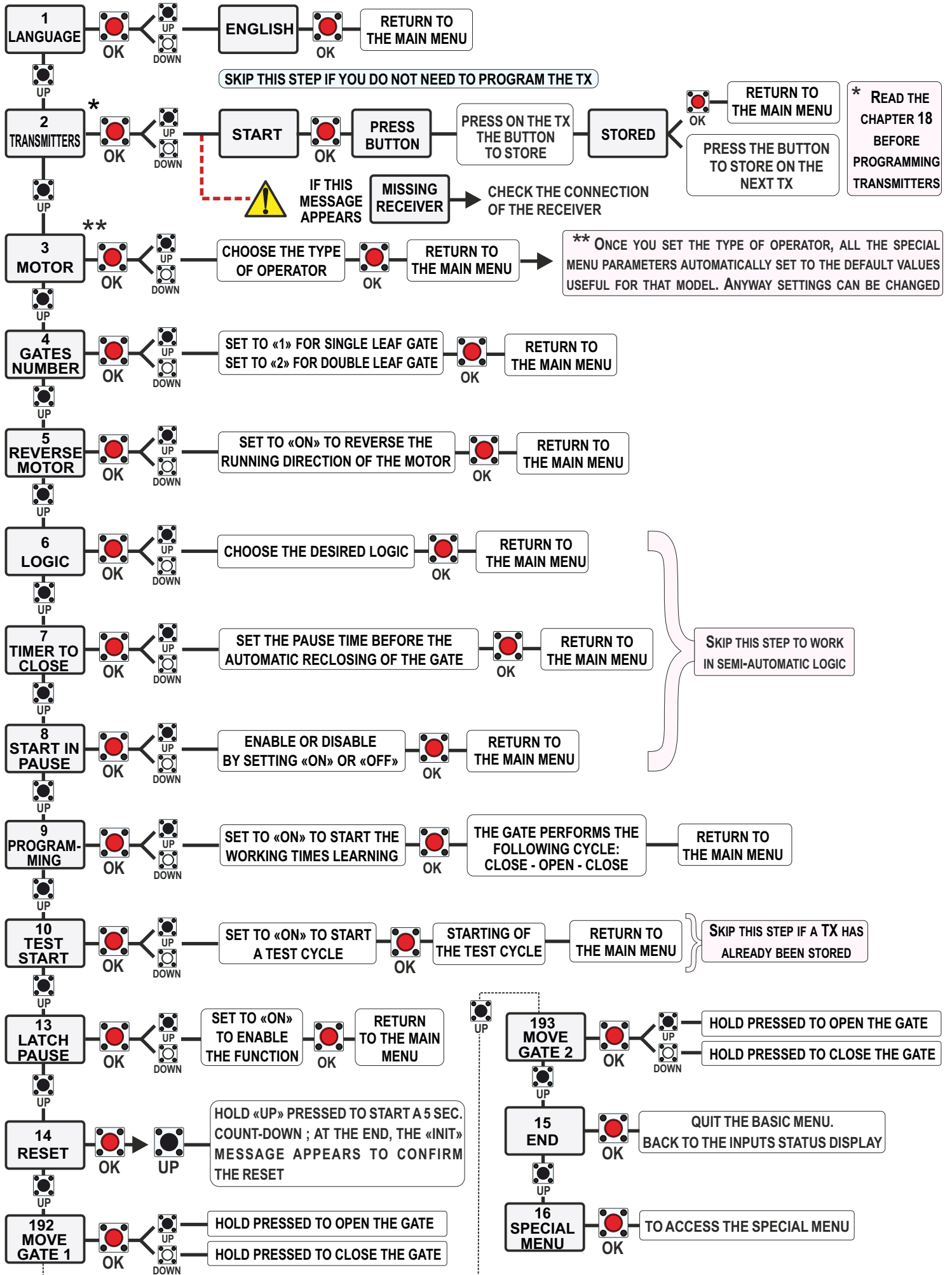

14 - INPUTS STATUS MANAGEMENT

14.1 - INPUTS DISPLAY on «SWING 2 DG R2F»

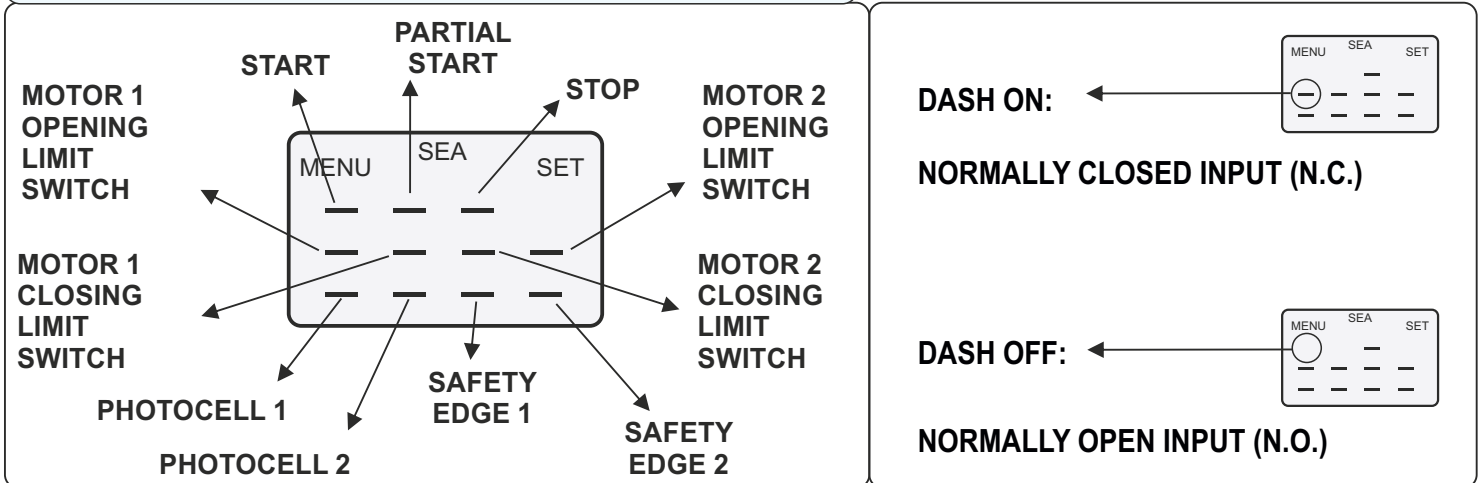

● *EXAMPLE: IF YOU GIVE A «START» COMMAND, ITS INPUT SWITCHES FROM NORMALLY OPEN TO NORMALLY CLOSED*

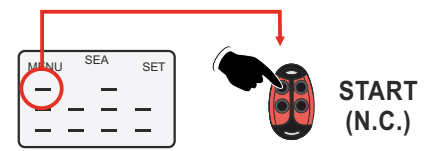

● *EXAMPLE: IF YOU PASS BY THE PHOTOCELL, ITS INPUT SWITCHES FROM NORMALLY CLOSED TO NORMALLY OPEN*

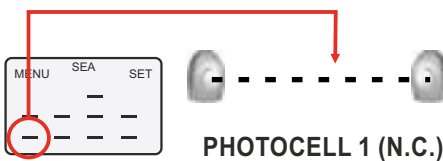

14.2 - INPUTS DISPLAY on «SWING 2 DG R2BF»

- EVERY INPUT CORRESPONDS TO A POSITION ON THE DISPLAY, ACCORDING TO THE DIAGRAM BELOW
- EVERY INPUT CAN BE: **NORMALLY OPEN (0)** - **NORMALLY CLOSED (1)**

0 N.O. - NORMALLY OPEN

1 N.C. - NORMALLY CLOSED

<p>1 2 3 4 5 6 7 8</p> <p>9 10 11 12 13 14 15 16</p>	<p>1 START (*)</p> <p>2 PARTIAL START</p> <p>3 STOP</p> <p>4 PHOTOCELL 1</p> <p>5 PHOTOCELL 2</p> <p>6 SAFETY EDGE 1</p> <p>7 SAFETY EDGE 2</p> <p>8 NOT IN USE</p>	<p>9 MOTOR 1 OPENING LIMIT SWITCH</p> <p>10 MOTOR 1 CLOSING LIMIT SWITCH</p> <p>11 MOTOR 2 OPENING LIMIT SWITCH</p> <p>12 MOTOR 2 CLOSING LIMIT SWITCH</p> <p>13 NOT IN USE</p> <p>14 NOT IN USE</p> <p>15 NOT IN USE</p> <p>16 NOT IN USE</p>
--	---	--

*** IF A TIMER IS CONNECTED TO THE START INPUT, IT KEEPS THE CONTACT NORMALLY CLOSED; IN THIS CASE THE DISPLAY WILL SHOW «T» ON POSITION N° 1**

● *EXAMPLE: IF YOU GIVE A «START» COMMAND, ITS INPUT SWITCHES FROM NORMALLY OPEN TO NORMALLY CLOSED*

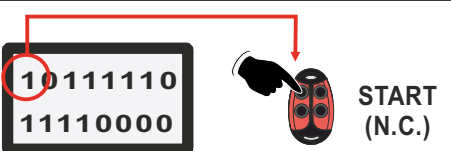
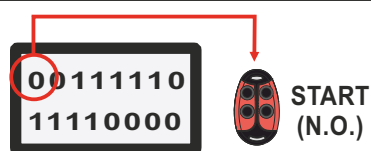

● *EXAMPLE: IF YOU PASS BY THE PHOTOCELL, ITS INPUT SWITCHES FROM NORMALLY CLOSED TO NORMALLY OPEN*

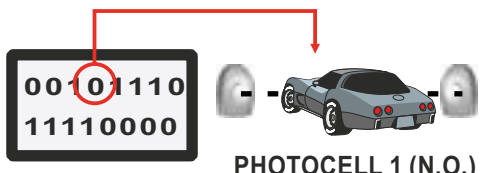
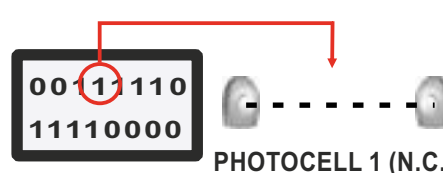

14.3 - ACCESS TO THE INPUTS MANAGEMENT MENU

GO ON ANY BASIC MENU NUMBER

1 LANGUAGE

HOLD PRESSED 5 SECONDS



INPUTS MANAGEMENT MENU

START OFF

THE MANAGEMENT MENU IS THE SAME IN BOTH MODELS

● THE «INPUTS MANAGEMENT MENU» SHOWS THE INPUTS IN THEIR CURRENT STATUS: ON OR OFF

(EXAMPLE)

START OFF

(EXAMPLE)

STOP ON

● INSIDE THE «INPUTS MANAGEMENT MENU» IT IS POSSIBLE TO ENABLE OR DISABLE THE INPUTS; **PAR. 14.4**

● **START E PARTIAL START ARE NORMALLY OPEN (N.O.) CONTACTS**

IF «ON» APPEARS ON THE DISPLAY WHEN THEY ARE ACTIVATED, THE INPUTS WORK

IF «OFF» IS DISPLAYED EVEN AFTER THE COMMAND ACTIVATION, THEN IT IS ADVISABLE TO CHECK THE WIRINGS

● **ALL OTHER CONTACTS ARE NORMALLY CLOSED (N.C.)**

IF «OFF» APPEARS ON THE DISPLAY WHEN THEY ARE ACTIVATED, THE INPUTS WORK

IF «ON» IS DISPLAYED EVEN AFTER THE COMMAND ACTIVATION, THEN IT IS ADVISABLE TO CHECK THE WIRINGS

➔ THE LIMIT SWITCHES INPUTS CANNOT BE MANAGED, BUT ONLY DISPLAYED IN THEIR CURRENT STATE (ON OR OFF)

14.4 - INPUTS MANAGEMENT MENU

1 LANGUAGE

THIS MENU ALLOWS TO ENABLE OR DISABLE THE INPUTS WITHOUT REPEATING THE WORKING TIMES LEARNING

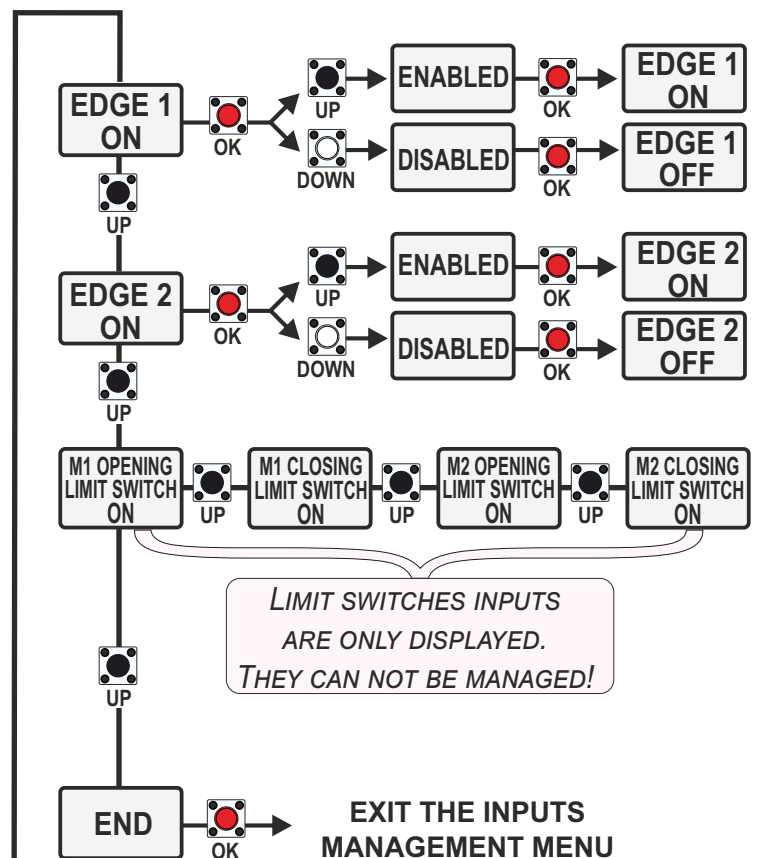
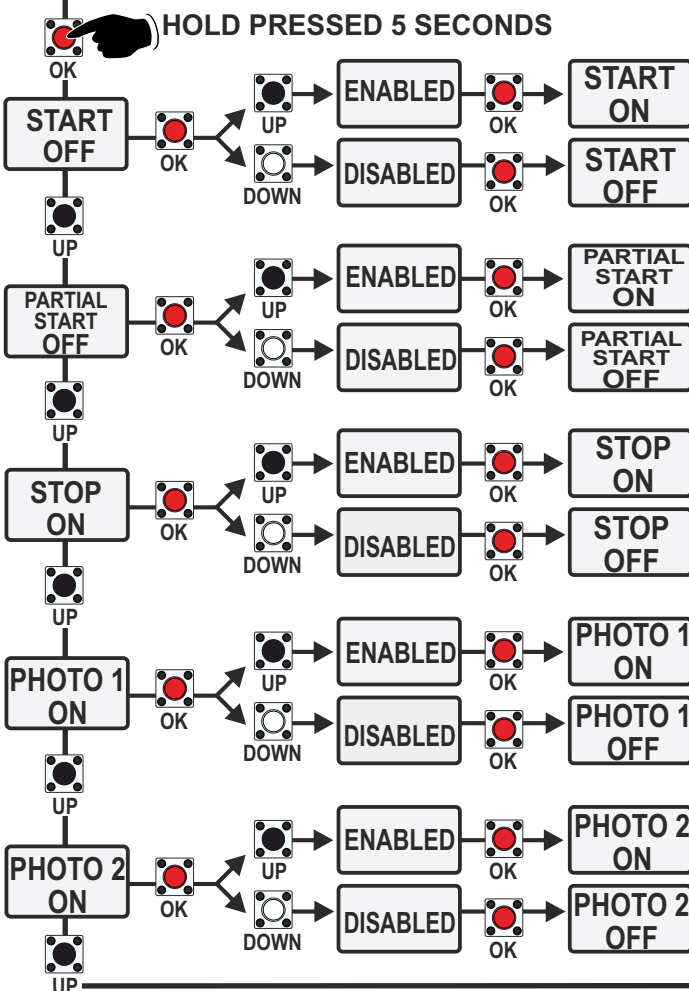

15 - WORKING TIMES LEARNING



DANGER!

HAVE A QUALIFIED SERVICE PERSON TO CARRY OUT THE OPERATIONS IN SAFE CONDITIONS

- ⇒ CHECK THE CORRECT OPERATION OF ALL ACCESSORIES (PHOTOCELLS, BUTTONS, ETC.)
- ⇒ DO NOT JUMPER THE INPUTS NOT IN USE (LIMIT SWITCH, SAFETY EDGE, ETC.)

15.1 - WORKING TIMES LEARNING BY LIMIT SWITCH

- WORKING TIMES LEARNING THROUGH AUTOMATIC DETECTION OF THE LIMIT SWITCHES
 - CHECK ON THE **INPUT MANAGEMENT MENU (CHAPTER 14)** THAT THE CORRECT LIMIT SWITCH IS ENGAGED FOR EACH MOVEMENT DIRECTION
 - START THE WORKING TIMES LEARNING BY FOLLOWING THE PROCEDURE IN **PARAGRAPH 15.5**
- ⇒ IF THE MOTOR **STARTS CLOSING**, REACHES THE LIMIT SWITCH LEVER AND STOPS, THEN SWAP THE **LIMIT SWITCH CABLES** AND REPEAT THE LEARNING PROCEDURE;
 IF THE MOTOR **STARTS OPENING**, REACHES THE LIMIT SWITCH LEVER AND STOPS, THEN SWAP THE **MOTOR CABLES** AND REPEAT THE LEARNING PROCEDURE

15.2 - WORKING TIMES LEARNING BY POTENTIOMETER

- WORKING TIMES LEARNING THROUGH AUTOMATIC DETECTION OF THE PULSES
- ENABLE THE POTENTIOMETER ON THE MENU 32 (**PARAGRAPH 9.3**)
- IF NECESSARY, CHECK THE CORRECT PULSES READING VIA THE SUB-MENUS 51 - 52 - 53 (**PARAGRAPH 9.4**)
- IF NECESSARY, ADJUST THE SENSITIVITY PARAMETERS (**PARAGRAPH 9.5**)
- START THE WORKING TIMES LEARNING BY FOLLOWING THE PROCEDURE IN **PARAGRAPH 15.5**
- AT THE END OF THE LEARNING PROCEDURE BY POTENTIOMETER, THE GATE CARRIES OUT THE FOLLOWING CYCLE: **M2 CLOSES - M1 CLOSES - M1 OPENS - M2 OPENS - M2 CLOSES - M1 CLOSES - M1 SLOWDOWN OPENING - M2 SLOWDOWN OPENING - M2 SLOWDOWN CLOSING - M1 SLOWDOWN CLOSING**

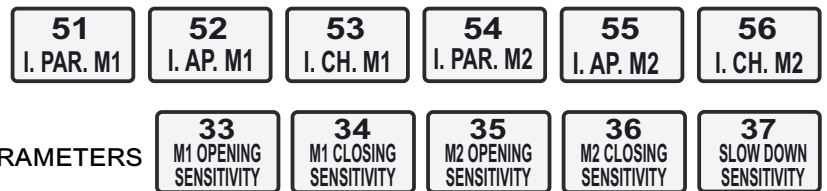
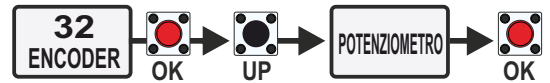

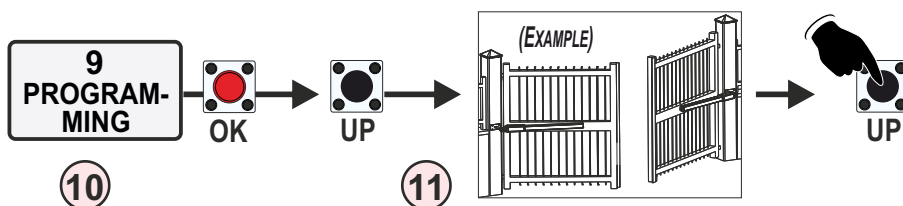
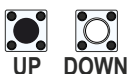

15.3 - WORKING TIMES LEARNING BY PULSES DETECTION - WITH POTENTIOMETER

- WORKING TIMES LEARNING THROUGH AUTOMATIC DETECTION OF THE PULSES AND POSSIBILITY TO CHOOSE THE GATE POINTS OF STOP
- ENABLE THE POTENTIOMETER AND CARRY OUT ALL THE CHECKS MENTIONED IN THE PREVIOUS PARAGRAPH
- START THE WORKING TIMES LEARNING BY FOLLOWING THE PROCEDURE IN **PARAGRAPH 15.5**, UP TO THE POINT 11. DURING THE LEARNING CYCLE, GIVE A MANUAL IMPULSE ON EACH DESIRED LEAF STOP POINT, USING THE KEYS OR BY GIVING A «START» COMMAND



DURING THE LEARNING CYCLE, PRESS «UP» ON THE DESIRED STOP POINTS

15.4 - WORKING TIMES LEARNING BY PULSES DETECTION - WITHOUT POTENTIOMETER

- WORKING TIMES LEARNING THROUGH MANUAL PULSES ON THE GATE POINTS OF STOP
- IF NECESSARY, MAKE THE DESIRED PARAMETERS ADJUSTMENTS INSIDE THE SPECIAL MENU
- START THE WORKING TIMES LEARNING BY FOLLOWING THE PROCEDURE IN **PARAGRAPH 15.5**, UP TO THE POINT **(11)**. DURING THE LEARNING CYCLE, GIVE A MANUAL IMPULSE ON EACH LEAF STOP POINT, USING THE KEYS   OR BY GIVING A «START» COMMAND

16
SPECIAL
MENU

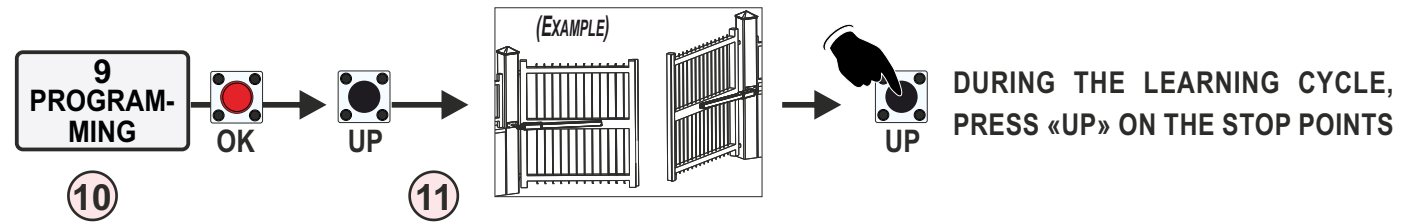

15.5 - WORKING TIMES LEARNING PROCEDURE

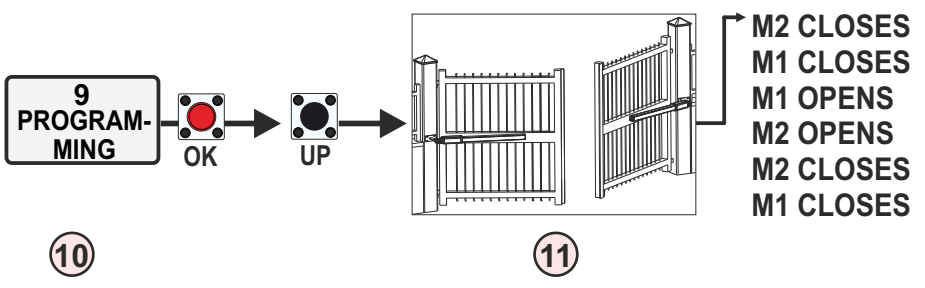
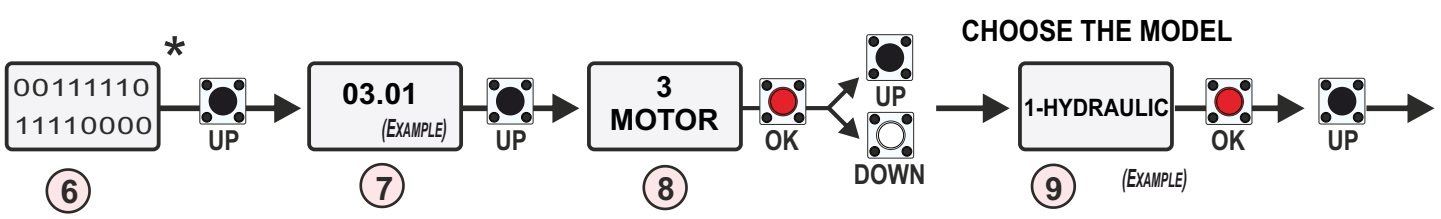
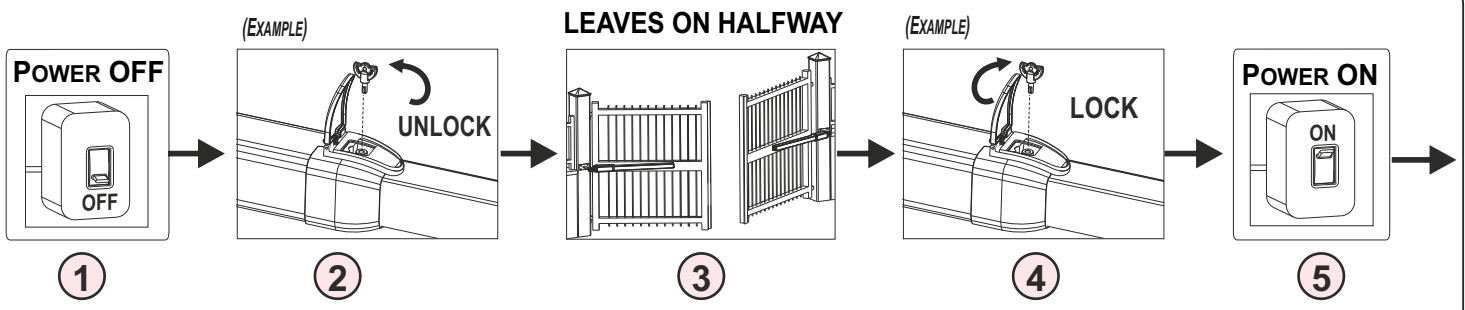

M2 CLOSES
M1 CLOSES
M1 OPENS
M2 OPENS
M2 CLOSES
M1 CLOSES

➔ IF THE OPERATOR PERFORMS THE FIRST LEARNING CYCLE STARTING IN OPENING, WAIT FOR THE END OF THE CYCLE AND REVERSE THROUGH THE MENU 5:
5 REVERSE MOTOR → **UP** → **ON**
THEN REPEAT THE LEARNING PROCEDURE

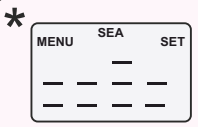

WHEN TURNED ON, THE CONTROL UNIT SHOWS THE INPUTS STATUS SCREEN.
THE SCREEN VARIES DEPENDING ON THE MODEL, AS EXPLAINED IN CHAPTER 12

16 - LOGICS



THE DEFAULT LOGIC IS «AUTOMATIC», ANYWAY IT CAN BE CHANGED BUT ONLY AFTER THE WORKING TIMES LEARNING!

- **SEMI-AUTOMATIC LOGIC:** AUTOMATICALLY SET WHEN THE MENU 7 IS «OFF» (**AUTOMATIC RECLOSING DISABLED**)

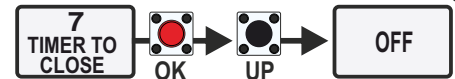

- OPERATION: A **START** COMMAND OPENS THE GATE; ANOTHER **START** COMMAND CLOSES; IN SEMI-AUTOMATIC LOGIC, THE AUTOMATIC RECLOSING IS ALWAYS DISABLED.
- THIS LOGIC MATCHES WITH OTHER LOGICS, KEEPING THE AUTOMATIC RECLOSING DISABLED

- **AUTOMATIC LOGIC:** PRE-SET BY DEFAULT. ANYWAY IT CAN BE MANUALLY ENABLED THROUGH THE MENU 6 OR THROUGH THE MENU 7 BY SETTING A PAUSE TIME DIFFERENT THAN 0 AND UP TO 240 SECONDS (**IT ALSO ENABLES THE AUTOMATIC RECLOSING**)

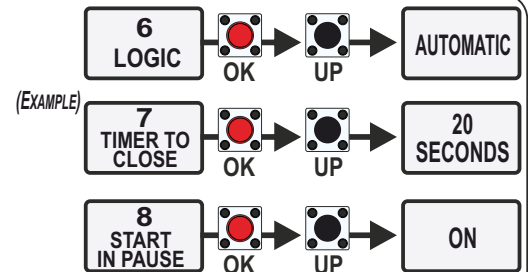

- THROUGH THE MENU 8 IT IS POSSIBLE TO CHOOSE IF A **START** COMMAND GIVEN DURING THE PAUSE TIME IS ACCEPTED OR NOT

- OPERATION: A **START** COMMAND OPENS THE GATE; ANOTHER **START** COMMAND DURING THE OPENING IS NOT ACCEPTED; A **START** COMMAND DURING THE CLOSING REVERSES THE MOVEMENT

- **SAFETY LOGIC:** A **START** COMMAND OPENS THE GATE; ANOTHER **START** COMMAND DURING THE OPENING REVERSES THE MOVEMENT A **START** COMMAND DURING THE CLOSING REVERSES THE MOVEMENT

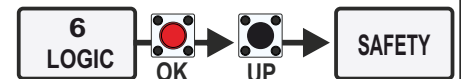

- **STEP BY STEP TYPE 1:** THE **START** COMMAND FOLLOWS THE LOGIC: **OPEN - STOP - CLOSE - STOP - OPEN**

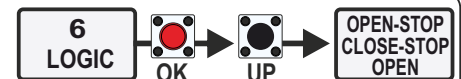

- **STEP BY STEP TYPE 2:** THE **START** COMMAND FOLLOWS THE LOGIC: **OPEN - STOP - CLOSE - OPEN**

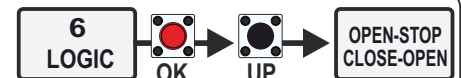

- **DEAD MAN LOGIC:** THE GATE OPENS AS LONG AS THE **START** COMMAND IS HELD PRESSED; WHEN RELEASED THE GATE STOPS. THE GATE CLOSES AS LONG AS THE **PARTIAL START** IS HELD PRESSED; WHEN RELEASED THE GATE STOPS.

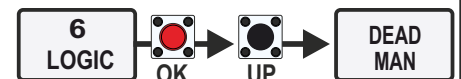

- **2 BUTTOS LOGIC:** A **START** COMMAND OPENS THE GATE, A **PARTIAL START** COMMAND CLOSES THE GATE. THE **PARTIAL START** COMMAND IS NOT ACCEPTED DURING THE OPENING. THE **START** COMMAND GIVEN DURING THE CLOSING REOPENS THE GATE, WHILE THE **PARTIAL START** COMMAND GIVEN DURING THE CLOSING IS IGNORED

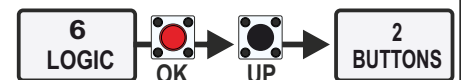

17 - PASSWORD

- ONCE THE PASSWORD IS ENABLED, ALL THE MENUS CAN NOT BE ADJUSTED, THEY ARE ONLY DISPLAYED
- IF YOU FORGET THE PASSWORD, CONTACT THE SEA TECHNICAL ASSISTANCE: **SEA RESERVES THE RIGHT TO EVALUATE AND DECIDE WHETHER TO PROVIDE OR NOT THE UNLOCKING PROCEDURE**

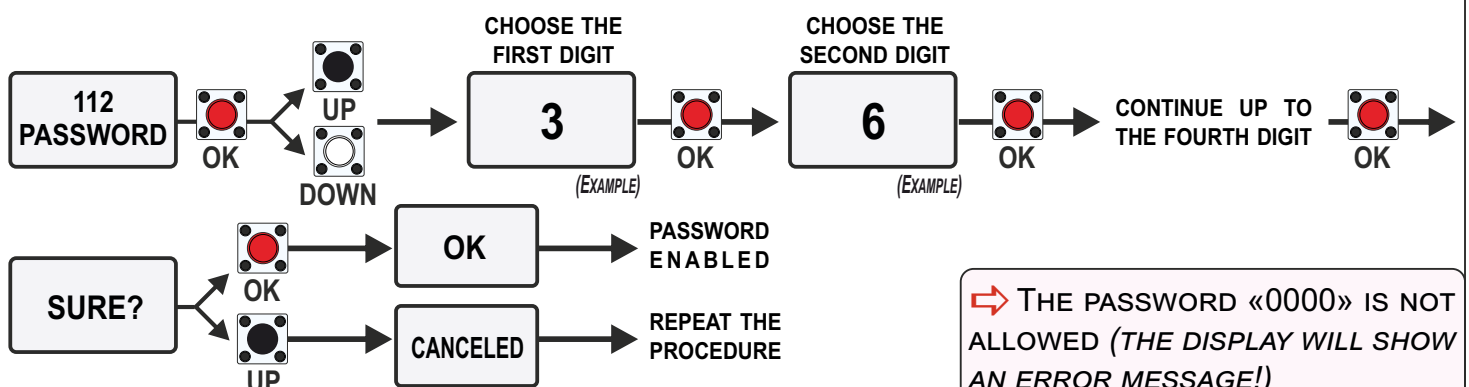

➡ THE PASSWORD «0000» IS NOT ALLOWED (THE DISPLAY WILL SHOW AN ERROR MESSAGE!)

18 - RECEIVERS AND TRANSMITTERS

- **WHEN THE CONTROL UNIT IS SWITCHED-OFF**, CHECK THE RECEIVER IS CORRECTLY PLUGGED IN
- PROGRAM THE TRANSMITTERS BEFORE CONNECTING THE ANTENNA
- PROGRAM THE TRANSMITTERS ONLY WHEN THE GATE IS CLOSED AND THE MOTOR IS STOPPED
- **RF UNI** AND **RF UNI PG** ALLOW THE USE OF BOTH **ROLL PLUS/UNI TX** AND **FIX CODE TX**
- **RF FIX** ALLOWS THE USE OF **FIX CODE** TRANSMITTERS ONLY
- IT IS POSSIBLE TO STORE UP TO 2 AMONG THE AVAILABLE FUNCTIONS
- THE **START** COMMAND MUST **ALWAYS** BE STORED (*ON THE FIRST CHANNEL*)
- IF THE SECOND STORED FUNCTION IS MODIFIED, THEN ALL THE TRANSMITTERS ACQUIRE THIS CHANGE ON THE SECOND CHANNEL

➔ **THE FIRST STORED TRANSMITTERS DETERMINES THE CODING OF THE FOLLOWING ONES**

EXAMPLE: IF THE FIRST TRANSMITTERS IS STORED AS ROLLING CODE, THEN ALL THE FOLLOWING TX MUST BE STORED AS ROLLING CODE; TRANSMITTERS WITH DIFFERENT CODING ARE NOT ACCEPTED

18.1 - OLD «ROLLING CODE» CODING

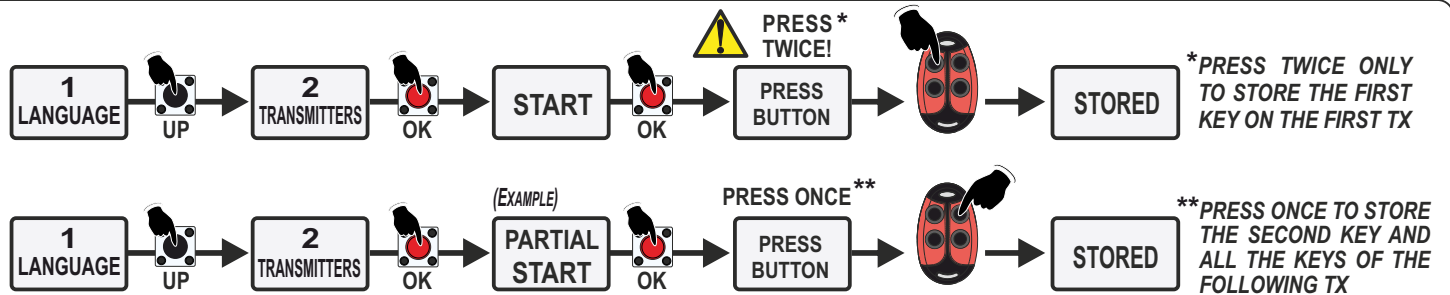

➔ MORE DETAILS ON THE FUNCTIONS AVAILABLE IN **PARAGRAPH 18.4**

18.2 - «ROLLING CODE PLUS» - «UNI» - «FIX CODE» TRANSMITTERS

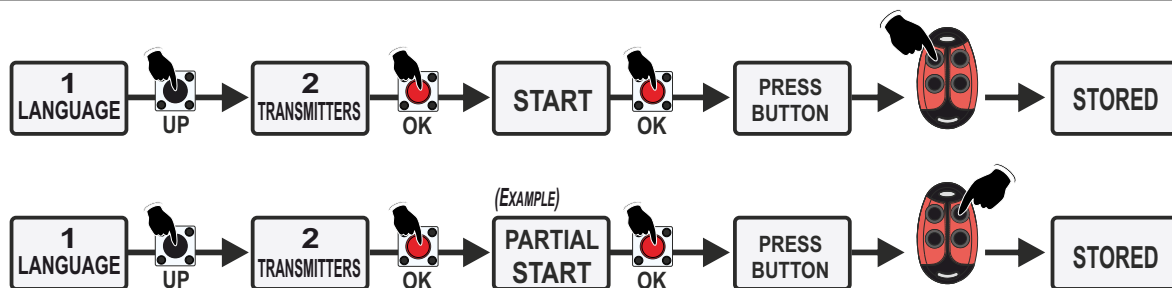

➔ MORE DETAILS ON THE FUNCTIONS AVAILABLE IN **PARAGRAPH 18.4**

18.3 - «START» COMMAND QUICK LEARNING

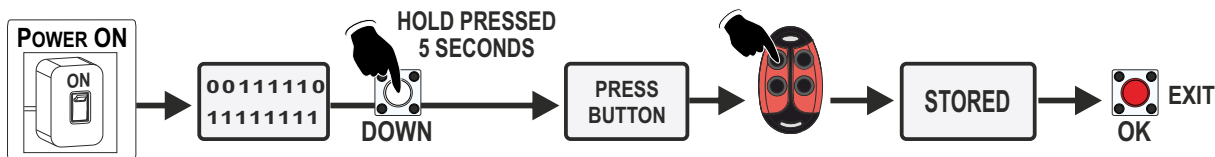

SEA PLUG-IN RECEIVERS (CHAPTER 10)	MAX. USERS NUMBER
RF UNI	16 USERS WITHOUT ADDITIONAL MEMORY 800 USERS WITH MEMO ADDITIONAL MEMORY
RF UNI PG (OLD MODEL - NON EXTRACTABLE MEMORY)	100 USERS FIX CODE 800 USERS ROLL PLUS
RF UNI PG (NEW MODEL - EXTRACTABLE MEMORY)	496 USERS FIX CODE 800 USERS ROLL PLUS
RF FIX	16 USERS WITHOUT ADDITIONAL MEMORY 100 USERS WITH MEMO ADDITIONAL MEMORY

18.4 - TRANSMITTERS FUNCTIONS DIAGRAM

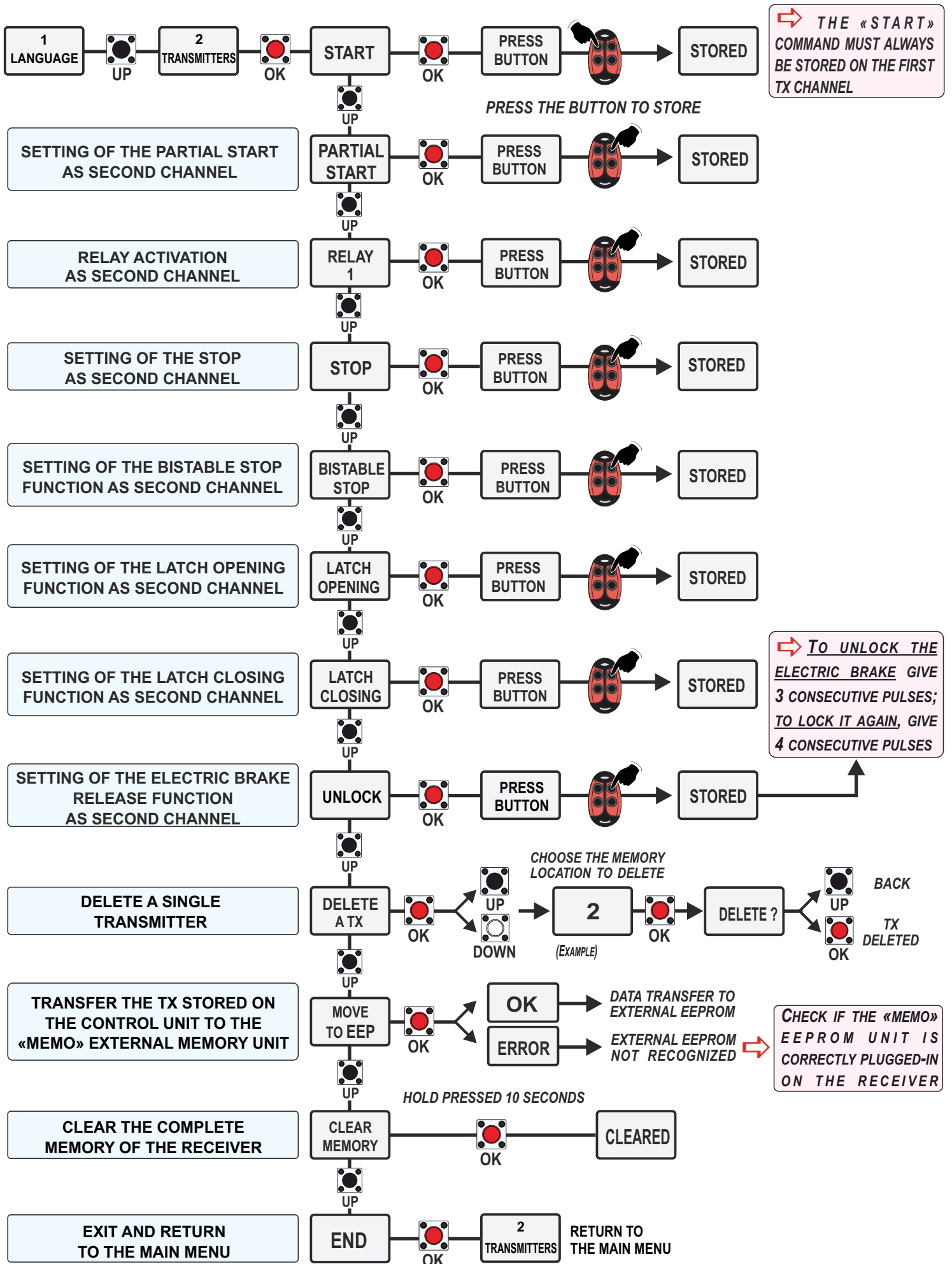

19 - ALARMS

19.1 - FAULTS SHOWN ON THE DISPLAY

● THE CONTROL UNIT ADVISES OF SOME FAULTS THROUGH A MESSAGE ON THE DISPLAY (*THEN PRESS OK TO EXIT*)

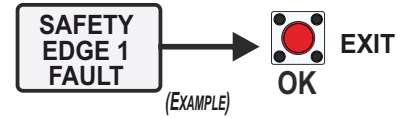

● BELOW THE LIST OF THE FAULTS THAT ARE SIGNALLED ON THE DISPLAY AND THE POSSIBLE SOLUTIONS TO THE PROBLEMS (*IF THE FAULT MESSAGE HOLDS OUT, CONTACT THE TECHNICAL SUPPORT*)

WARNING MESSAGE	SOLUTION
FAULT MOTOR	MOTOR POWER SUPPLY FAULT - CHECK THAT THERE ARE NO SHORT CIRCUITS ON THE MOTOR OR ON THE CONTROL UNIT; CHECK THAT THE GATE IS NOT BLOCKED OR STUCKED ON A STOP POINT. UNLOCK THE OPERATOR AND GIVE A START COMMAND TO CHECK THAT THE MOTOR RUNS : IF THE MOTOR RUNS THEN DISCONNECT THE POWER SUPPLY, LOCK THE OPERATOR AGAIN AND RESTORE THE POWER SUPPLY; IF THE MOTOR DOES NOT RUN, THEN IT IS BURNED
FAULT 24	24V OR 24VAUX POWER SUPPLY FAULT - CHECK THAT THERE ARE NO SHORT CIRCUITS ON WIRINGS OR ON THE CONTROL UNIT; CHECK THAT THERE IS NO OVERLOAD
FAULT NET	MAIN POWER SUPPLY FAULT - CHECK THAT A POWER FAILURE IS NOT OCCURRED; CHECK THAT THE MAIN POWER SUPPLY IS ACTIVE; CHECK THE FUSE F2
FAULT SELF-TEST PHOTO 1	FULT DETECTED BY THE «PHOTOCELLS SELF-TEST» FUCTION - CHECK THE OPERATION OF THE PHOTOCELL 1 AND/OR THE WIRINGS ON THE CONTROL UNIT
FAULT SELF-TEST PHOTO 2	FULT DETECTED BY THE «PHOTOCELLS SELF-TEST» FUCTION - CHECK THE OPERATION OF THE PHOTOCELL 2 AND/OR THE WIRINGS ON THE CONTROL UNIT
FAULT LIMIT SWITCH	LIMIT SWITCH ACTIVATION FAULT - CHECK THE OPERATION OF BOTH LIMIT SWITCHES AND THAT THERE IS A CORRESPONDENCE BETWEEN THE DIRECTION OF MOVEMENT OF THE MOTOR AND THE LIMIT SWITCH ENGAGED
FAULT POTENTIOMETER	POTENTIOMETER FAULT - THE MESSAGE APPEARS ONLY IF THE POTENTIOMETER HAS BEEN ENABLED ON MENU 32-POTENTIOMETER, BUT THE POTENTIOMETER MANAGEMENT UNIT (LE / LSE) IS DAMAGED OR NOT CONNECTED;
FAULT POTENTIOMETER 1 DIRECTION	POTENTIOMETER 1 CABLE WIRING ERROR - SWAP THE CONNECTION CABLES OF THE POTENTIOMETER ON THE LE/LSE MANAGEMENT UNIT (<i>SWAP THE BLUE CABLE - OR GREEN - WITH THE BROWN CABLE</i>)
FAULT POTENTIOMETER 1 DIRECTION	POTENTIOMETER 2 CABLE WIRING ERROR - SWAP THE CONNECTION CABLES OF THE POTENTIOMETER ON THE LE/LSE MANAGEMENT UNIT (<i>SWAP THE BLUE CABLE - OR GREEN - WITH THE BROWN CABLE</i>)
FAULT FLASHING LIGHT	FLASHING LIGHT FAULT - CHECK THE WIRINGS AND / OR THE CONDITION OF THE LAMP
FAULT SAFETY EDGE	SAFETY EDGE FAULT - CHECK THE METAL WIRE OF THE SAFETY EDGE AND THE CABLES WIRINGS. CHECK THAT THE CONTACT IS CLOSED BY ACCESSING THE «INPUT STATUS» MENU (<i>PARAGRAPH 14.3</i>)
FAULT ENCODER	ENCODER FAULT - THE SIGNAL APPEARS ONLY IF THE ENCODER HAS BEEN ACTIVATED ON THE 32-ENCODER MENU BUT THE LE / LSE MANAGEMENT CARD IS DAMAGED OR NOT CONNECTED. VERIFY THAT THE OPERATOR IS NOT STUCK.
PASSWORD ERROR	PASSWORD ERROR - ENTER THE PASSWORD CORRECTLY; IT IS NOT POSSIBLE TO SET «0000» AS A PASSWORD; IF YOU FORGOT THE PASSWORD, PLEASE CONTACT THE TECHNICAL ASSISTANCE.

19.2 - FAULTS SIGNALLED ON THE FLASHING LIGHT

● IT IS ALSO POSSIBLE TO VISUALIZE THE WARNING SIGNALS THROUGH THE FLASHING LIGHT SIMPLY BY OBSERVING THE NUMBER OF FLASHES EMITTED (**SEE THE TABLE OF CORRESPONDENCES ASIDE**)

● WHEN AN EVENT OCCURS, THE WARNING FLASHES ARE ISSUED AT EACH «START» COMMAND

➔ **THE «CYCLES ALARM» WARNING REFERS TO THE REACHING OF THE MAXIMUM CYCLES ESTABLISHED AFTER WHICH MAINTENANCE IS NECESSARY**

NUMBER OF FLASHES	CORRESPONDING ALARM TYPE
9 SLOW (EVERY 0.5 SEC)	MOTORS FAILURE
2 SLOW (EVERY 0.5 SEC)	PHOTOCELL FAILURE DURING CLOSING
3 SLOW (EVERY 0.5 SEC)	PHOTOCELL FAILURE DURING OPENING
6 SLOW (EVERY 0.5 SEC)	COLLISION-OBSTACLE DETECTED DURING OPENING
6 SLOW (EVERY 0.5 SEC)	COLLISION-OBSTACLE DETECTED DURING CLOSING
4 SLOW (EVERY 0.5 SEC)	SAFETY EDGE FAILURE
5 SLOW (EVERY 0.5 SEC)	FAULT ON STOP CONTACT
7 SLOW (EVERY 0.5 SEC)	MAX. CYCLES ACHIEVED-MAINTENANCE REQUIRED
4 FAST (EVERY 0.2 SEC)	LIMIT SWITCH FAILURE OR ERROR

19.3 - «DIAGNOSTICS» MENU TO DISPLAY LATEST EVENTS

● SOME OF THE WARNINGS AND ALARMS REMAIN IN THE CONTROL UNIT MEMORY, UP TO A MAX. OF 10 EVENTS. TO SEE THE STORED EVENTS, ACCESS THE MENU 106

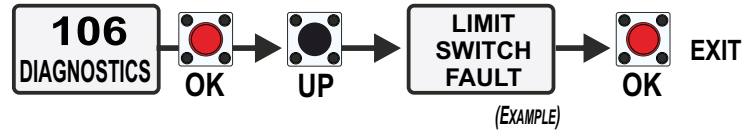

➔ IF THE FAULT MESSAGE HOLDS OUT, CARRY OUT THE REQUIRED CHECKS OR DISCONNECT THE DEVICE GENERATING THE FAULT



IT IS ALWAYS RECOMMENDED TO CONSULT THE CHAPTER 20 DEDICATED TO TROUBLESHOOTING. MOST OF THE PROBLEMS CAN BE SOLVED BY FOLLOWING THE INSTRUCTIONS GIVEN!

20 - TROUBLESHOOTING



MAKE SURE THAT ALL THE SAFETY DEVICES ARE «ON»





PROBLEM	POSSIBLE REASON	SOLUTION
The operator does not respond to any START command	a) Check that the N.C. are connected b) Blown fuse	a) Check the connections and the jumpers on the safety edge or stop or photocell inputs, if connected b) Replace the blown fuse on the control unit
The operator does not run and the diagnostic display is off	a) The control unit is not powered b) Fuse open c) Defective control unit	a) Check the AC power supply b) Check the fuses c) Replace the defective control unit
The operator does not respond to a wired command (example: Opening, Closing, etc.)	a) Check the inputs of the opening and closing commands b) The STOP button is activated c) The Reset button is blocked d) Anti-entrapment safety device active	a) Check all the opening and closing inputs to make sure they are not blocked b) Check the STOP button is not blocked c) Check the Reset button d) Check among all the inputs of the anti-entrapment protection device, if there is a blocked sensor
The operator does not respond to a remote control	a) The STOP button is activated b) The Reset button is blocked c) Poor radio reception	a) Check the STOP button is not blocked b) Check the Reset button c) Check if the other wired devices are working correctly; check the antenna cable
The motor runs in one direction only	a) Check the resistance between the motor phase and neutral and verify that the resistance is MOhm b) Try to invert the motor phase and see if it changes direction or not	a) Replace the cable b) If the motor is blocked, replace the cable; if the motor moves in one direction only, the motor direction relay is damaged
The gate does not move but the motor runs	a) The engine is in the locked position b) Presence of an obstacle	a) Release the motor b) Remove the obstacle
The gate does not reach the complete open or closed position	a) Wrong limit switch setting b) Programming error c) Gate is stopped by an obstacle d) Torque too low e) The gate is too heavy to perform the automatic slowdown	a) Set the limit switches b) Repeat the working times programming c) Remove the obstacle d) Increase the torque parameter e) Set the slowdown to OFF
The gate opens but does not close	a) The photocells contacts are connected and open b) Stop contact connected and open c) The safety edge contact is open d) Amperometric alarm	a) b) c) Check the jumpers or the connected devices or the warning signals on the flashing lamp d) Check for a possible the amperometric alarm and, if necessary, increase the torque parameter
The gate does not close automatically	a) Pause time set too high b) Semi-automatic logic control unit	a) Adjust the pause time b) Set the PAUSE TIME menu to a value different than OFF
The gate moves, but the limit switches cannot be set correctly	a) The gate does not move towards a stop position b) It is too difficult to move the gate	a) Manually unlock and move the gate and make sure the gate moves easily from limit switch to limit switch. If necessary, repair the gate b) The gate must be able to move easily and freely throughout its travel, from limit switch to limit switch. If necessary, repair the gate
The gate does not fully open or close when the limit switches are set	a) The gate does not move towards a limit switch b) It is too difficult to move the gate	a) Manually unlock and move the gate and make sure the gate moves easily from limit switch to limit switch. If necessary, repair the gate b) The gate must be able to move easily and freely throughout its travel, from limit switch to limit switch. If necessary, repair the gate
The gate stops during travel and reverses direction	a) Open/Close control active b) The obstacle detection sensitivity is too low	a) Check if there is an active input among all the opening and closing inputs b) Check the obstacle detection sensitivity value and try to increase it
The gate opens but does not close with TX or closing timer	a) Opening control active b) Pause not set c) The closing anti-entrapment protection device is active d) The photocell contact is open e) The fire switch input is active	a) Check if there is an active input among the open inputs b) Check the pause settings c) Check if there is an active sensor among all the inputs of the anti-entrapment protection device d) Check the contact of the photocells e) Check the fire switch input

PROBLEM	POSSIBLE REASON	SOLUTION
The gate does not respect the slowdown start points	<ul style="list-style-type: none"> a) The encoder does not work properly when activated b) Slow mechanical clutch c) Too large deceleration space d) The potentiometer does not work correctly when activated e) The parameters of the recovery position are too high or too low 	<ul style="list-style-type: none"> a) Check in the Encoder menu that the "Encoder Par" parameter is set from a low value of +/- 10 (gate completely closed) to "Encoder tot" (gate completely open). If the IPAR movement is not in line with the range of values (from +/- 10 to "Encoder tot") probably the encoder is defective b) Tighten the mechanical clutch c) Reduce the slowdown space d) Check in the Potentiometer menu that the "IPAR" parameter is set from "I.CH." (gate completely closed) to "I.AP." (gate completely open). If the "IPAR" movement is not in line with the range of values (from I.AP. to I.CH.), the potentiometer is probably faulty e) Reduce or increase the values of the "recovery position"
The gate opens suddenly but any START command have been given	<ul style="list-style-type: none"> a) Frequency or disturbances on the main line b) Short-circuit on the START contact 	<ul style="list-style-type: none"> a) The AC wiring must be separated from the DC wires and run through separate conduits. If it is a frequency disturbance, you can change the frequency to another MHz value, such as 868 or FM b) Check all the START contacts
The gate does not accept the close command during the pause in automatic logic, even if the loop or photocell are set as Start	<ul style="list-style-type: none"> a) START IN PAUSE is not ON b) The photocell/loop input is not set as "pause reload" 	<ul style="list-style-type: none"> a) Turn ON the START IN PAUSE menu b) Set "pause reload" in the photocell / loop menu
The gate does not have the necessary force to close or reach the limit switch	<ul style="list-style-type: none"> a) Slowing down is not possible either because the gate is too heavy or because of the inclination or because the installation is not new 	<ul style="list-style-type: none"> a) Set the slowdown to OFF
The gate travel is obstructed and cannot stop or reverse	<ul style="list-style-type: none"> a) Force the necessary adjustment 	<ul style="list-style-type: none"> a) Refer to the adjustment parameter to carry out the obstruction tests and make the correct adjustments of the force (sensitivity - torque)
The photocell does not stop or reverse the gate travel	<ul style="list-style-type: none"> a) The photocell wiring is incorrect b) The photocell is faulty c) The photocells have been installed too far apart 	<ul style="list-style-type: none"> a) Check the photocell wiring. Check that the gate stops and reverses its direction when the photocell is engaged b) Replace the faulty photocell. Check that the gate stops and reverses its direction when the photocell is engaged c) Install the photocells closer or use safety edges with sensors
The safety edge does not stop or reverse the travel of the gate	<ul style="list-style-type: none"> a) Incorrect wiring of the edge sensor b) Defective edge sensor 	<ul style="list-style-type: none"> a) Check the safety edge wiring. Check that the gate stops and reverses its direction when the edge is activated b) Replace the defective safety edge and check that the gate stops and reverses its direction when it is activated
The alarm sounds for 5 minutes or the alarm sounds after a command	<ul style="list-style-type: none"> a) A double entrapment has occurred (two obstructions within a single activation) 	<ul style="list-style-type: none"> a) Check the cause of the entrapment detection (obstruction) and correct it. Press the reset button to silence the alarm and reset the operator
The shadow loop does not hold the gate on the opening limit switch	<ul style="list-style-type: none"> a) Shadow loop sensor incorrectly adjusted b) Defective shadow loop sensor c) Wrong setting 	<ul style="list-style-type: none"> a) Check the shadow loop settings and reset as needed b) Replace the defective vehicle sensor c) Check that menu 98 is on SHADOW LOOP
The accessories connected to the accessory power supply do not work properly, they turn off or restart	<ul style="list-style-type: none"> a) Accessory power supply protection active b) Defective electronic control unit 	<ul style="list-style-type: none"> a) Disconnect all devices powered by the "accessories power supply" and measure their voltage (must be 23-30 Vdc). If the voltage is correct, reconnect the accessories one at a time, measuring each time the voltage b) Replace the defective control unit
Fault on the 24VAUX	<ul style="list-style-type: none"> a) Overload/short-circuit on AUX input b) Blown fuse 	<ul style="list-style-type: none"> a) Check if the cable is shorted b) Replace the fuse
The control unit turns on but the motor does not run	<ul style="list-style-type: none"> a) STOP active or wrong jumpers b) Open or close the active input c) Active Entrapment Protection Device d) Defective electronic control unit 	<ul style="list-style-type: none"> a) Check that the STOP button is not blocked, that it is a N.C. contact or put a jumper on the Stop input b) Check that none of the opening and closing inputs are blocked c) Check whether there is a blocked sensor among all the entrapment protection device inputs d) Replace the defective control unit

SWING 2 DG (R2F) - (R2BF) MENU FUNCTIONS TABLE

THE DESCRIBED FUNCTIONS ARE VALID FOR ALL SWING 2 DG VERSIONS, EXCEPT WHERE EXPRESSLY STATED

MENU		SET	DESCRIPTION	DEFAULT	NOTE
1	LANGUAGE	<i>Italiano</i>	Italian	English	
		<i>English</i>	English		
		<i>Français</i>	French		
		<i>Español</i>	Spanish		
		<i>Dutch</i>	Dutch		
2	TRANSMITTERS	<i>Start</i>	Start	Start Partial Opening	
		<i>Partial opening</i>	Partial opening		
		<i>Relay</i>	To enable the Relay for 3 seconds		
		<i>Stop</i>	Stop		
		<i>Bistable Stop</i>	Pressed once, it stops the gate. Pressed twice, it reactivates the START input		
		<i>Latch opening</i>	One impulse opens and keep open. A second impulse restore the movement		
		<i>Latch closing</i>	One impulse closes and keep closed. A second impulse restore the movement		
		<i>Unlock</i>	To store a command for unlocking the electric brake		
		<i>Delete a transmitter</i>	To delete a single transmitter (TX)		
		<i>Move to EEP</i>	To transfer the transmitters stored on the control unit to the external EEPROM (MEM), if connected		
		<i>Clear memory</i>	To delete the full transmitters memory on the receiver		
<i>End</i>	To exit the menu "transmitters"				
3	MOTOR	1- Hydraulic	Hydraulic operators	Mechanic	
		2- Sliding	Sliding operators		
		3- Reversible Sliding	Reversible sliding operators		
		4- Mechanic Swing	Electro-mechanic swing operators		
		11- Cougar	Electro-mechanic swing operator		
4	GATES NUMBER	<i>From 1 to 2</i>	To set the number of motors to be managed	1	
5	REVERSE MOTOR	<i>On</i>	To reverse the opening with the closing and vice-versa (both motors and limit-switches are reversed)	Off	
		<i>Off</i>	Off		
6	LOGIC	<i>Automatic</i>	Automatic logic - automatic reclosing enabled	Auto- matic	
		<i>Open-stop-close-stop-open</i>	Step by step type 1		
		<i>Open-stop-close-open</i>	Step by step type 2		
		<i>2 button</i>	Two buttons		
		<i>Safety</i>	Safety		
		<i>Dead man</i>	Dead man		

MENU		SET		DESCRIPTION	DEFAULT	NOTE	
7	TIMER TO CLOSE	Off		Semi-automatic logic enabled (a START command opens and another START closes the gate - automatic reclosing disabled)	Off		
		1	240	To set a pause time (from 1 second to 4 minutes) before the automatic reclosing			
8	START IN PAUSE	Off		The Start command is not accepted during pause	Off		
		On		The Start command is accepted during pause			
9	PROGRAMMING	Off	On	To start the working times self-learning	Off		
10	TEST START	Off	On	To give a Start command for testing the automation	Off		
13	LATCH PAUSE	Off	On	If "ON" the operator complies with the pause time set when the function "LATCH OPENING" is disabled. When "OFF" the pause time set is not respected	Off		
14	RESET	A count-down of 5 seconds will start by holding the UP button; at its end "INIT" will appear on the display as confirmation of the control board reset					
192	MOVE GATE 1 *	Allows the movement of the gate in a temporary "dead man" mode <i>(for example to test the correct running of the motor)</i> HOLD UP PRESSED = THE GATE OPENS HOLD DOWN PRESSED = THE GATE CLOSES			  UP DOWN	----	
193	MOVE GATE 1 *	Allows the movement of the gate in a temporary "dead man" mode <i>(for example to test the correct running of the motor)</i> HOLD UP PRESSED = THE GATE OPENS HOLD DOWN PRESSED = THE GATE CLOSES			  UP DOWN	----	
* The command is accepted only at the end of the cycle or after a STOP command; it is not accepted during the cycle and during the pause							
15	END	Press OK to return to the display of the firmware version and to the one of inputs state					
16	SPECIAL MENU	Press OK to enter the special menu					



SPECIAL MENU



PRESS AT THE SAME TIME FOR 5 SECONDS TO ENTER OR TO EXIT THE SPECIAL MENU

THE DESCRIBED FUNCTIONS ARE VALID FOR ALL SWING 2 DG VERSIONS, EXCEPT WHERE EXPRESSLY STATED

SPECIAL MENU		SET		DESCRIPTION	DEFAULT	NOTE
26	LEAF DELAY IN OPENING	Off	6	Setting from OFF to 6 seconds	1,5	
27	LEAF DELAY IN CLOSING	Off	20	Setting from OFF to 20 seconds	2,5	
28	OPENING TORQ 1	30%	100%	Motor 1 opening torque: by increasing the torque, more strength will be required to execute the inversion in case of obstacle. with hydraulic motors the torque will be on 100%	75	
29	CLOSING TORQ 1	30%	100%	Motor 1 closing torque: by increasing the torque, more strength will be required to execute the inversion in case of obstacle. with hydraulic motors the torque will be on 100%	75	
30	OPENING TORQ 2	30%	100%	Motor 2 opening torque: by increasing the torque, more strength will be required to execute the inversion in case of obstacle. with hydraulic motors the torque will be on 100%	75	
31	CLOSING TORQ 2	30%	100%	Motor 2 closing torque: by increasing the torque, more strength will be required to execute the inversion in case of obstacle. with hydraulic motors the torque will be on 100%	75	
32	ENCODER	<i>On</i> (only if connected via LSE management unit)		ON = Encoder enabled OFF = Encoder disabled (when OFF, the working times learnt are only shown)	<i>Off</i>	
	47 ENCODER PAR. M1	xxx.		Impulses read by Encoder during operation (Motor 1)		
	48 ENCODER TOT. M1	xxx.		Impulses stored during programming (Motor 1)		
	49 ENCODER PAR. M2	xxx.		Impulses read by Encoder during operation (Motor 2)		
	50 ENCODER TOT. M2	xxx.		Impulses stored during programming (Motor 2)		
32	ENCODER	<i>Potentiometer</i>		To enable the reading of the potentiometer (only if connected via LE or LSE management unit)	<i>Off</i>	
51	I.PAR.M1 *	-----		To show the current position of the potentiometer on the leaf moved by Motor 1 . This parameter is useful to see if the potentiometer is correctly read		
52	I.AP.M1	From the value learned to ± 100 pulses		To show the impulses stored by the control unit when the leaf moved by Motor 1 is fully open		
53	I.CH.M1	From the value learned to ± 100 pulses		To show the impulses stored by the control unit when the leaf moved by Motor 1 is fully close		
54	I.PAR.M2 *	-----		To show the current position of the potentiometer on the leaf moved by Motor 2 . This parameter is useful to see if the potentiometer is correctly read		
55	I.AP.M2	From the value learned to ± 100 pulses		To show the impulses stored by the control unit when the leaf moved by Motor 2 is fully open		
56	I.CH.M2	From the value learned to ± 100 pulses		To show the impulses stored by the control unit when the leaf moved by Motor 2 is fully close		

* While the partial impulses are displayed, it is possible to OPEN (by pressing UP) or CLOSE (by pressing DOWN) the operator to verify the correct reading of the potentiometer

SPECIAL MENU		SET	DESCRIPTION	DEFAULT	NOTE
32	ENCODER	<i>Off</i>	ON = Encoder enabled OFF = Encoder disabled (when OFF, the working times learnt are only shown)	<i>Off</i>	
	65 OPENING TIME M1	xxx.s	To display the learnt value during the working times self learning, in opening and closing (Motor 1) . With UP or DOWN it is possible to increase or reduce the working times		
	66 CLOSING TIME M1	xxx.s			
	67 OPENING TIME M2	xxx.s			
	68 CLOSING TIME M2	xxx.s			
33	OPENING SENSITIVITY MOTOR 1	10% (<i>Fast intervention</i>) 99% (<i>Slow intervention</i>)	To adjust the Encoder or Potentiometer intervention time on Motor 1 in opening	<i>Off</i>	
		<i>Off (Intervention excluded)</i>	Disabled		
34	CLOSING SENSITIVITY MOTOR 1	10% (<i>Fast intervention</i>) 99% (<i>Slow intervention</i>)	To adjust the Encoder or Potentiometer intervention time on Motor 1 in closing	<i>Off</i>	
		<i>Off (Intervention excluded)</i>	Disabled		
35	OPENING SENSITIVITY MOTOR 2	10% (<i>Fast intervention</i>) 99% (<i>Slow intervention</i>)	To adjust the Encoder or Potentiometer intervention time on Motor 2 in opening	<i>Off</i>	
		<i>Off (Intervention excluded)</i>	Disabled		
36	CLOSING SENSITIVITY MOTOR 2	10% (<i>Fast intervention</i>) 99% (<i>Slow intervention</i>)	To adjust the Encoder or Potentiometer intervention time on Motor 2 in closing	<i>Off</i>	
		<i>Off (Intervention excluded)</i>	Disabled		
37	SLOWDOWN SENSITIVITY MOTOR	10% (<i>Fast intervention</i>) 99% (<i>Slow intervention</i>)	To adjust the reversing sensitivity during slowdown Function available only with Encoder connected via LSE management unit	<i>Off</i>	
		<i>With potentiometer</i>	To set the inversion time in slow-down from 0 to 5 seconds (= 99%) - Function available only with Potentiometer connected via LSE management unit		
38	POTENTIOMETER THRESHOLD OPENING 1	0 1000	To adjust the threshold of the potentiometer intervention. This parameter self-determines during the working times learning but can also be adjusted later, on the condition that the set value is higher than the value shown in VP1 or VP2 (<u>instantaneous speed values which can be shown by accessing the DEBUG menu</u>). NOTE: The lower the threshold value, the slower will be the response of the potentiometer.	<i>It depends on model</i>	
39	POTENTIOMETER THRESHOLD CLOSING 1				
40	POTENTIOMETER THRESHOLD OPENING 2				
41	POTENTIOMETER THRESHOLD CLOSING 2				
42	POTENTIOMETER SLOWDOWN THRESHOLD IN OPENING M1	0 100	To adjust the threshold of the potentiometer intervention in slowdown. By default this value is set on 10. but can be manually increased on the condition that the set value is higher than the value shown in VP1 or VP2 (instantaneous speed values which can be shown by accessing the DEBUG menu)	<i>It depends on model</i>	
43	POTENTIOMETER SLOWDOWN THRESHOLD IN CLOSING M1				
44	POTENTIOMETER SLOWDOWN THRESHOLD IN OPENING M2				
45	POTENTIOMETER SLOWDOWN THRESHOLD IN CLOSING M2				

SPECIAL MENU		SET		DESCRIPTION	DEFAULT	NOTE
46	CLOSING INVERSION	Total		In case of obstacle or safety edge it totally reverses the movement during closing. If the automatic reclosing is enabled (automatic logic), it is attempted for 5 times	Partial	
		Partial		In case of obstacle, safety edge or potentiometer, it partially reverses direction (of about 30 cm) then stops		
For menus 47 - 48 - 49 - 50 see menu 32- ENCODER = On						
For menus 51 - 52 - 53 - 54 - 55 - 56 see menu 32- ENCODER = Potentiometer						
59	OPENING SLOWDOWN 1	Off (*)	50% Hydraulic	Adjustable from Off to the 50% of the stroke. On hydraulic operators, the slowdown is automatically set to "Hydraulic" if value exceeds the 50%	It depends on model	
60	CLOSING SLOWDOWN 1	Off (*)	50% Hydraulic	Adjustable from Off to the 50% of the stroke. On hydraulic operators, the slowdown is automatically set to "Hydraulic" if value exceeds the 50%	It depends on model	
61	OPENING SLOWDOWN 2	Off (*)	50% Hydraulic	Adjustable from Off to the 50% of the stroke. On hydraulic operators, the slowdown is automatically set to "Hydraulic" if value exceeds the 50%	It depends on model	
62	CLOSING SLOWDOWN 2	Off (*)	50% Hydraulic	Adjustable from Off to the 50% of the stroke. On hydraulic operators, the slowdown is automatically set to "Hydraulic" if value exceeds the 50%	It depends on model	
* For motors with hydraulic brake (CF) or double hydraulic brake (2CF) this parameter must be on Off						
63	DECELERATION	0 % 100%		To adjust the change from normal speed to slowdown speed	100%	
64	ACCELERATION	0 % 100%		Acceleration ramp. To adjust the motor start	100%	
For menus 65 - 66 - 67 - 68 see menu 32- ENCODER = Off						
69	ANTI OVERLAP	Off		To disable the anti-overlapping control of the leaves allowing their separate control	Off	
		On		To enable the anti-overlapping control of the leaves		
70	OPENING POSITION RECOVERY	0	20 seconds	To retrieve the inertia of the motor in opening after the Stop or the reversing	1s	
71	CLOSING POSITION RECOVERY	0	20 seconds	To retrieve the inertia of the motor in closing after the Stop or the reversing	1s	
72	OPENING TOLERANCE MOTOR 1	0	100	To adjust the Motor 1 tolerance between the stop and the obstacle, in opening	80	
73	CLOSING TOLERANCE MOTOR 1	0	100	To adjust the Motor 1 tolerance between the stop and the obstacle, in closing	80	
74	OPENING TOLERANCE MOTOR 2	0	100	To adjust the Motor 2 tolerance between the stop and the obstacle, in opening	80	
75	CLOSING TOLERANCE MOTOR 2	0	100	To adjust the Motor 2 tolerance between the stop and the obstacle, in closing	80	
76	PUSHING STROKE	Time Pushing Stroke		Off - 3 sec	Off	
		Repeat Lock Release		Off - On		
		End		To exit the menu		

SPECIAL MENU		SET	DESCRIPTION	DEFAULT	NOTE
77	LOCK TIME	<i>Off</i> 5 seconds	To adjust the lock release time from 0 to 5 seconds	3	
78	LOCK	<i>Only opening</i>	Lock enabled only before opening	<i>Opening and closing</i>	
		<i>Only closing</i>	Lock enabled only before closing		
		<i>Opening and closing</i>	Lock enabled before opening and closing		
79	ANTI INTRUSION	<i>Only opening</i>	If the gate is forced manually, the control unit starts the motor and restores the state of the gate before forcing (function only available if limit switches are installed)	<i>Off</i>	
		<i>Only closing</i>			
		<i>Opening and closing</i>			
		<i>Off</i>			
80	PUSHOVER	<i>Off</i>	The gate leaf makes an extra movement at the maximum torque to ensure the tightening of the gate	<i>Off</i>	
		<i>Opening and closing</i>			
		<i>Only closing</i>			
		<i>Only opening</i>			
81	PERIODICAL PUSHOVER	<i>Off</i> 8h	To activate the repetition of the pushover function at a time distance adjustable from 0 to 8 hours, at hourly intervals	<i>Off</i>	
82	MOTOR RELEASE	<i>Opening 1</i> <i>Off - 3 s</i>	If different from OFF, the operator slightly reverses its direction at the end of the cycle	<i>Off</i> <small>(hydraulic)</small> 0.1 <small>(mechanic)</small>	
		<i>Closing 1</i> <i>Off - 3 s</i>			
		<i>Opening 2</i> <i>Off - 3 s</i>			
		<i>Closing 2</i> <i>Off - 3 s</i>			
		<i>End</i>			
83	EXTRA TIME *	0.0 s 10 s	If the limit switches are installed, it is possible to add an extra time (max. 10 seconds) to the movement of the operator after the reading of the limit switches	0.0 s	
<p>* Only if the operator is equipped with hydraulic slowdown and one or more slowdown-menus (from 59 to 62) are set to "HYDRAULIC" (EXTRA TIME will be applied to the operator and to the moving direction of the menu set to "HYDRAULIC")</p>					
84	BRAKE	<i>Off</i> 100%	To adjust the braking on the limit switch	<i>Off</i>	
85	PRE-FLASHING	<i>Only closing</i>	To enable the pre-flashing only before closing (to access: press DOWN button when 0.0 value is shown)	<i>Off</i>	
		0.0 5.0 s	To set the pre-flashing duration		
86	FLASHING LIGHT	<i>Normal</i>	Normal	<i>Normal</i>	
		<i>Light</i>	Warning lamp function		
		<i>Always</i>	Always ON		
		<i>Buzzer</i>	Buzzer		
87	FLASHING LIGHT AND TIMER	<i>Off</i>	The flashing light will be OFF with enabled timer and open gate	<i>Off</i>	
		<i>On</i>	The flashing light will be ON with enabled timer and open gate		
88	COURTESY LIGHT	<i>Off</i>	Disabled	<i>In cycle</i>	
		1 240	Adjustable from 1 second to 4 minutes		
		<i>In cycle</i>	Courtesy light only in cycle		
89	TRAFFIC LIGHT RESERVATION	<i>Off</i> <i>On</i>	To get the priority in entry or exit. The function is available only with SEM management unit and by the use of the partial opening contact	<i>Off</i>	
90	PARTIAL OPENING	20 100	Adjustable from 20 to 100	100	

SPECIAL MENU		SET	DESCRIPTION	DEFAULT	NOTE
91	PARTIAL PAUSE	= Start	The pause time in partial opening is the same as in total opening	= Start	
		Off	Disabled		
		1 240	Adjustable from 1 second to 4 minutes		
92	TIMER	Off	The selected input will be turned into an input (on CN1) to which connect an external clock	Off	
		On photo2			
		On partial input			
94	24V AUX (Max. 500 mA) The AUX output allows the connection of a relay for the additional accessories management	Always	AUX output always powered	Always	
		In cycle	AUX output powered only during cycle		
		Opening	AUX output powered only during opening		
		Closing	AUX output powered only during closing		
		In pause	AUX output powered only during pause		
		Positive brake management (via relay)	Positive Electric-brake - connected via relay (AUX output powered only with stationary gate)		
		Negative brake management (connected via relay)	Negative Electric-brake - connected via relay (AUX output powered during cycle and 1 second before starting the movement)		
		Open gate warning light (connected via relay)	1 flash per second during opening 2 flashes per second during closing Steady lit in "Stop" or "Open" status		
Start 3 s (connected via relay)	AUX output powered at every Start input or at every photocells or safety edge intervention, for 3 seconds (ie. management of lights connected via relay)				
95	PHOTO-TEST	Photo 1	Self-test enabled only on photocell 1	Off	
		Photo 2	Self-test enabled only on photocell 2		
		Photo 1 and 2	Self-test enabled on photocells 1 and 2		
		Off	Disabled		
97	PHOTOCELL 1	Closing	If the photocell is occupied during closing, the gate reverses the movement; If the photocell is occupied during the pause, it prevents the gate reclosing	Closing	
		Opening and closing	If the photocell is occupied during opening or closing, it stops the gate movement; when the photocell is released, the movement continues		
		Stop	If the photocell is occupied before the Start input, the Start will be ignored. If the photocell is occupied after the Start input, the photocell will be ignored. If the photocell is occupied during closing, the gate will reopen		
		Stop and close	If the photocell is occupied during closing, it stops the gate movement; when released, the closing movement continues		
		Close	The photocell stops the gate until it is occupied in both opening and closing; when released, it send a closing input (the gate closes 1s after the photocell release)		
		Pause reload	If the photocell is occupied during opening or closing, it stops the gate movement; when released, the movement continues. If the photocell is occupied during the pause, it recharges the pause time set		
		Delete pause time	If the photocell is occupied during opening, pause or closing, the gate reopens completely and closes without observing the pause time set		

SPECIAL MENU		SET	DESCRIPTION	DEFAULT	NOTE
98	PHOTOCELL 2	<i>Closing</i>	If the photocell is occupied during closing, the gate reverses the movement; If the photocell is occupied during the pause, it prevents the gate reclosing	Opening and Closing	
		<i>Opening and closing</i>	If the photocell is occupied during opening or closing, it stops the gate movement; when the photocell is released, the movement continues		
		<i>Stop</i>	If the photocell is occupied before the Start input, the Start will be ignored. If it is occupied after the Start input, the photocell will be ignored. If the photocell is occupied during closing, the gate will reopen		
		<i>Stop and close</i>	If the photocell is occupied during closing, it stops the gate; when released the closing movement continues		
		<i>Close</i>	The photocell stops the gate until it is occupied in both opening and closing; when released, the photocell gives a closing command (<i>the gate closes one second after the photocell release</i>)		
		<i>Pause reload</i>	If the photocell is occupied during opening or closing, it stops the gate movement; when released, the movement continues. If the photocell is occupied during the pause, it reloads the pause time set		
		<i>Pause reload Photo closing</i>	If the photocell is occupied during the pause, it reloads the pause time set. If the photocell is occupied during closing, the gate reverses the movement		
		<i>Delete pause time</i>	If the photocell is occupied during opening, pause or closing, the gate reopens completely and closes without observing the pause time set		
		<i>Stop and open</i>	If the photocell is occupied during opening, the gate will stop; when released, the gate continues the opening movement. The photocell is ignored during closing		
			<i>Safety edge 2</i>		
100	SAFETY EDGE 1 Menu available on model R2F only	<i>Normal</i>	Standard safety edge - N.C. contact	Normal	
		<i>8K2</i>	<u>S</u> afety edge protected by a 8K2 resistor enabled		
	SAFETY EDGE 1 Menu available on model R2BF only	<i>Normal</i>	Standard safety edge - N.C. contact		
		<i>8K2 N.C.</i>	<u>S</u> afety edge protected by a 8K2 resistor enabled		
		<i>8K2 N.C. Double</i>	Two safety edges protected by 8K2 resistor enabled		
		<i>8K2 RES</i>	Resistive edge protected by 8K2 resistor enabled		
<i>8K2 RES Double</i>	Two resistive edges protected by 8K2 RES enabled				
102	SAFETY EDGE 1 DIRECTION	<i>Opening and closing</i>	Safety edge enabled in opening and closing	Opening and Closing	
		<i>Only opening</i>	Safety edge enabled only in opening		
		<i>Only closing</i>	Safety edge enabled only in closing		
103	SAFETY EDGE 2 DIRECTION Menu available only if the menu 98 is set on "SAFETY EDGE 2"	<i>Opening and closing</i>	Safety edge enabled in opening and closing	Opening and Closing	
		<i>Only opening</i>	Safety edge enabled only in opening		
		<i>Only closing</i>	Safety edge enabled only in closing		

SPECIAL MENU		SET		DESCRIPTION	DEFAULT	NOTE
104	SELECT LIMIT SWITCH	<i>Automatic</i>		Automatic detection of the limit switch	<i>Auto-matic</i>	
		<i>Only opening</i>		Limit switch enabled only in opening		
		<i>Only closing</i>		Limit switch enabled only in closing		
		<i>Motor internal</i>		To be enabled if the operator is equipped with an inner limit switch that stops the motor phase		
106	DIAGNOSTICS	<i>1</i>	<i>10</i>	To display the last event (See alarms table)	----	
107	MAINTENANCE CYCLES	<i>100</i>	<i>240000</i>	Adjustable from 100 to 240000 cycles	<i>100000</i>	
108	PERFORMED CYCLES	<i>0</i>	<i>240000</i>	To display the executed cycles. Hold pressed OK to reset the cycles	<i>0</i>	
112	PASSWORD	Note: "0000" setting is not allowed		To enter a password for blocking the control unit parameters modification	----	
114	EXP MANAGEMENT	SEM 2		The SEM 2 management unit can be connected to the EXP input	<i>SEM2</i>	
		Relay		A relay unit can be connected to the EXP input		
116	REPEAT LEAF DELAY	<i>On</i>	<i>Off</i>	In case of a STOP command when the gate is halfway, the leaves will repeat the "leaf delay" set (menu 26-27)	<i>On</i>	
118	LATCH	<i>Off</i>		Disabled	<i>Off</i>	
		<i>Opening</i>		The gate opens and stay open till a new Start input. The latch function uses the "Partial Opening" N.O. input (the "Partial Opening" function is so disabled)		
		<i>Closing</i>		The gate closes and stay closed till a new Start input. The latch function uses the "Partial Opening" N.O. input (the "Partial Opening" function is so disabled)		
119	DISPLAY WRITING SPEED	<i>From 30% to 100%</i>		See Note 2 at the end of the table	<i>80%</i>	
120	BASIC MENU	Press OK to exit the special menu. The special menu switches off automatically after 20 minutes				
121	PHOTO 1 TYPE Menu available on model R2BF only	<i>Normal</i>		Standard photocell without 10K control	<i>Normal</i>	
		<i>Photo 1 10K</i>		Photocell with 10K control		
122	PHOTO 2 TYPE Menu available on model R2BF only	<i>Normal</i>		Standard photocell without 10K control	<i>Normal</i>	
		<i>Photo 2 10K</i>		Photocell with 10K control		
132	RELAY Menù visibile solo sul modello R2BF	<i>Start 3s</i>		To enable the Relay for 3 seconds at every Start or reopening command	<i>Start 3s</i>	
		<i>Off</i>		Disabled		
190	BASIC MENU On model R2BF only	Press OK to exit the special menu. The special menu switches off automatically after 20 minutes				
<p>Note 1: after initialization, the parameters set on menu 3 - MOTOR and 104 - SELECT LIMIT SWITCH always remain set to the value chosen during the programming operation</p> <p>Note 2: if the menu 119 - DISPLAY WRITING SPEED is set to the minimum value of 30%, the display writing speed will be low. On the contrary, if it is set to the maximum value of 100%, the writing speed will be very high</p> <p>Please note: the writing speed will not change on the JOLLY 3 programmer</p>						

TO THE ATTENTION OF BOTH INSTALLER AND END USER

MAINTENANCE: Periodically, based on the number of maneuvers performed over time and based on the type of operator, if a change in friction, malfunctioning or non-compliance with the previously set times are noticed, **it would be advisable to reprogram the learning times on the control unit**

Periodically clean the optical systems of the photocells

REPLACEMENTS: Send request for spare parts to: **SEA S.p.A. - Teramo - ITALY - www.seateam.com**

SAFETY AND ENVIRONMENTAL COMPATIBILITY: Disposal of packaging materials and/or circuits should take place in an approved disposal facility





REGULAR PRODUCT DISPOSAL (electric and electronic waste)

(It's applicable in EU countries and in those ones provided with a differential waste collection)

This brand on the product or on documentation indicates that the product must not be disposed off together with other domestic waste at the end of its life cycle. In order to avoid any possible environmental or health damage caused by irregular waste disposal, we recommend to separate this product from other types of waste and to recycle it in a responsible way in order to provide the sustainable re-use of material resources. Domestic users are invited to contact the retailer where the product has been purchased or the local office to get all the information related to differential waste collection and recycling of this kind of product

STORING

WAREHOUSING TEMPERATURES			
T _{min}	T _{Max}	Dampness _{min}	Dampness _{Max}
- 20°C 	+ 65°C 	5% <i>not condensing</i>	90% <i>not condensing</i>

Materials handling must be made with appropriate vehicles

WARRANTY LIMITS - see the sales conditions

SEA S.p.A. reserves the right to make any required modification or change to the products and/or to this manual without any advanced notice obligation

GENERAL NOTICE FOR THE INSTALLER AND THE USER

1. **Read carefully these instructions** before beginning to install the product. Store these instructions for future reference
2. Don't waste product packaging materials and /or circuits.
3. This product was designed and built strictly for the use indicated in this documentation. Any other use, not expressly indicated here, could compromise the good condition/operation of the product and/or be a source of danger. SEA S.p.A. declines all liability caused by improper use or different use in respect to the intended one.
4. The mechanical parts must be comply with Directives: Machine Regulation 2006/42/CE and following adjustments), Low Tension (2006/95/CE), electromgnetic Consistency (2004/108/CE) Installation must be done respecting Directives: EN12453 and En12445.
5. Do not install the equipment in an explosive atmosphere.
6. SEA S.p.A. is not responsible for failure to observe Good Techniques in the construction of the locking elements to motorize, or for any deformation that may occur during use.
7. Before attempting any job on the system, cut out electrical power and disconnect the batteries. Be sure that the earthing system is perfectly constructed, and connect it metal parts of the lock.
8. Use of the indicator-light is recommended for every system, as well as a warning sign well-fixed to the frame structure.
9. SEA S.p.A. declines all liability as concerns the automated system's security and efficiency, if components used, are not produced by SEA S.p.A..
10. For maintenance, strictly use original parts by SEA.
11. Do not modify in any way the components of the automated system.
12. The installer shall supply all information concerning system's manual functioning in case of emergency, and shall hand over to the user the warnings handbook supplied with the product.
13. Do not allow children or adults to stay near the product while it is operating. The application cannot be used by children, by people with reduced physical, mental or sensorial capacity, or by people without experience or necessary training. Keep remote controls or other pulse generators away from children, to prevent involuntary activation of the system.
14. Transit through the leaves is allowed only when the gate is fully open.
15. The User must not attempt to repair or to take direct action on the system and must solely contact qualified SEA personnel or SEA service centers. User can apply only the manual function of emergency.
16. The power cables maximum length between the central engine and motors should not be greater than 10 m. Use cables with 2,5 mm² section. Use double insulation cable (cable sheath) to the immediate vicinity of the terminals, in particular for the 230V cable. Keep an adequate distance (at least 2.5 mm in air), between the conductors in low voltage (230V) and the conductors in low voltage safety (SELV) or use an appropriate sheath that provides extra insulation having a thickness of 1 mm.

TERMS OF SALES

EFFICACY OF THE FOLLOWING TERMS OF SALE: the following general terms of sale shall be applied to all orders sent to SEA S.p.A. All sales made by SEA to all costumers are made under the prescription of this terms of sales which are integral part of sale contract and cancel and substitute all apposed clauses or specific negotiations present in order document received from the buyer.

GENERAL NOTICE The systems must be assembled exclusively with SEA components, unless specific agreements apply. Non-compliance with the applicable safety standards (European Standards EM12453 – EM 12445) and with good installation practice releases SEA from any responsibilities. SEA shall not be held responsible for any failure to execute a correct and safe installation under the above mentioned standards.

1) PROPOSED ORDER The proposed order shall be accepted only prior SEA approval of it. By signing the proposed order, the Buyer shall be bound to enter a purchase agreement, according to the specifications stated in the proposed order.

On the other hand, failure to notify the Buyer of said approval must not be construed as automatic acceptance on the part of SEA.

2) PERIOD OF THE OFFER The offer proposed by SEA or by its branch sales department shall be valid for 30 solar days, unless otherwise notified.

3) PRICING The prices in the proposed order are quoted from the Price List which is valid on the date the order was issued. The discounts granted by the branch sales department of SEA shall apply only prior to acceptance on the part of SEA. The prices are for merchandise delivered ex-works from the SEA establishment in Teramo, not including VAT and special packaging. SEA reserves the right to change at any time this price list, providing timely notice to the sales network. The special sales conditions with extra discount on quantity basis (Qx, Qx1, Qx2, Qx3 formula) is reserved to official distributors under SEA management written agreement.

4) PAYMENTS The accepted forms of payment are each time notified or approved by SEA. The interest rate on delay in payment shall be 1.5% every month but anyway shall not be higher than the max. interest rate legally permitted.

5) DELIVERY shall take place, approximately and not peremptorily, within 30 working days from the date of receipt of the order, unless otherwise notified. Transport of the goods shall be at Buyer's cost and risk. SEA shall not bear the costs of delivery giving the goods to the carrier, as chosen either by SEA or by the Buyer. Any loss or damage of the goods during transport, are at Buyer's cost

6) COMPLAINTS Any complaints and/or claims shall be sent to SEA within 8 solar days from receipt of the goods, proved by adequate supporting documents as to their truthfulness.

7) SUPPLY The concerning order will be accepted by SEA without any engagement and subordinately to the possibility to get it's supplies of raw material which is necessary for the production; Eventual completely or partially unsuccessful executions cannot be reason for complains or reservations for damage. SEA supply is strictly limited to the goods of its manufacturing, not including assembly, installation and testing. SEA, therefore, disclaims any responsibility for damage deriving, also to third parties, from non-compliance of safety standards and good practice during installation and use of the purchased products.

8) WARRANTY The standard warranty period is 12 months. This warranty time can be extended by means of expedition of the warranty coupon as follows:

SILVER: The mechanical components of the operators belonging to this line are guaranteed for 24 months from the date of manufacturing written on the operator.

GOLD: The mechanical components of the operators belonging to this line are guaranteed for 36 months from the date of manufacturing written on the operator.

PLATINUM: The mechanical components of the operators belonging to this line are guaranteed for 36 months from the date of manufacturing written on the operator. The base warranty (36 months) will be extended for further 24 months (up to a total of 60 months) when it is acquired the certificate of warranty which will be filled in and sent to SEA S.p.A. The electronic devices and the systems of command are guaranteed for 24 months from the date of manufacturing. In case of defective product, SEA undertakes to replace free of charge or to repair the goods provided that they are returned to SEA repair centre. The definition of warranty status is by unquestionable assessment of SEA. The replaced parts shall remain propriety of SEA. Binding upon the parties, the material held in warranty by the Buyer, must be sent back to SEA repair centre with fees prepaid, and shall be dispatched by SEA with carriage forward. The warranty shall not cover any required labour activities.

The recognized defects, whatever their nature, shall not produce any responsibility and/or damage claim on the part of the Buyer against SEA. The guarantee is in no case recognized if changes are made to the goods, or in the case of improper use, or in the case of tampering or improper assembly, or if the label affixed by the manufacturer has been removed including the SEA registered trademark No. 804888. Furthermore, the warranty shall not apply if SEA products are partly or completely coupled with non-original mechanical and/or electronic components, and in particular, without a specific relevant authorization, and if the Buyer is not making regular payments. The warranty shall not cover damage caused by transport, expendable material, faults due to non-conformity with performance specifications of the products shown in the price list. No indemnification is granted during repairing and/or replacing of the goods in warranty. SEA disclaims any responsibility for damage to objects and persons deriving from non-compliance with safety standards, installation instructions or use of sold goods. The repair of products under warranty and out of warranty is subject to compliance with the procedures notified by SEA.

9) RESERVED DOMAIN A clause of reserved domain applies to the sold goods; SEA shall decide autonomously whether to make use of it or not, whereby the Buyer purchases propriety of the goods only after full payment of the latter.

10) COMPETENT COURT OF LAW In case of disputes arising from the application of the agreement, the competent court of law is the tribunal of Teramo. SEA reserves the faculty to make technical changes to improve its own products, which are not in this price list at any moment and without notice. SEA declines any responsibility due to possible mistakes contained inside the present price list caused by printing and/or copying. The present price list cancels and substitutes the previous ones. The Buyer, according to the law No. 196/2003 (privacy code) consents to put his personal data, deriving from the present contract, in SEA archives and electronic files, and he also gives his consent to their treatment for commercial and administrative purposes.

Industrial ownership rights: once the Buyer has recognized that SEA has the exclusive legal ownership of the registered SEA brand num.804888 affixed on product labels and / or on manuals and / or on any other documentation, he will commit himself to use it in a way which does not reduce the value of these rights, he won't also remove, replace or modify brands or any other particularity from the products. Any kind of replication or use of SEA brand is forbidden as well as of any particularity on the products, unless preventive and expressed authorization by SEA.

In accomplishment with art. 1341 of the Italian Civil Law it will be approved expressly clauses under numbers:

4) PAYMENTS - 8) GUARANTEE - 10) COMPETENT COURT OF LAW



Automatic Gate Openers
International registered trademark n. 804888

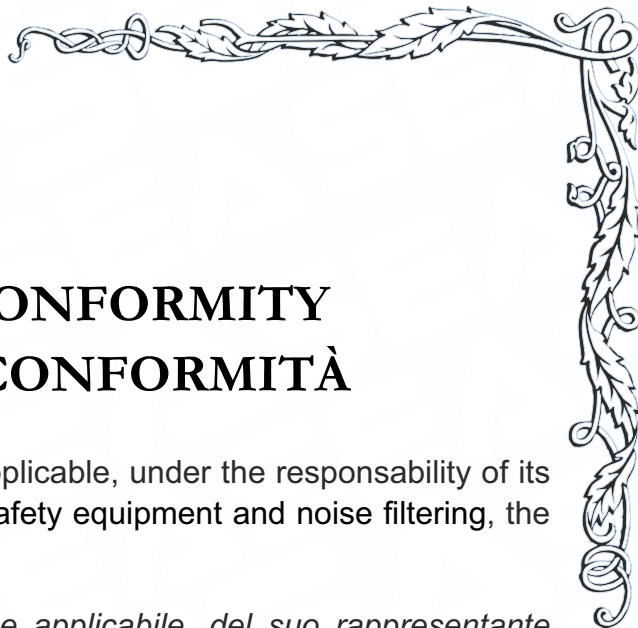

DECLARATION OF CONFORMITY DICHIARAZIONE DI CONFORMITÀ

SEA S.p.A. declares under its proper responsibility and, if applicable, under the responsibility of its authorised representative that, by installing the appropriate safety equipment and noise filtering, the products:

La SEA S.p.A. dichiara sotto la propria responsabilità e, se applicabile, del suo rappresentante autorizzato che, con l'installazione degli adeguati dispositivi di sicurezza e di filtraggio disturbi, i prodotti:

DESCRIPTION - DESCRIZIONE	MODEL - MODELLO	TRADEMARK - MARCA
SWING 2 DG R2F (AND ALL ITS BY-PRODUCTS - E TUTTI I SUOI DERIVATI)	23021096	SEA

are built to be integrated into a machine or to be assembled with other machinery to create a machine under the provisions of Directive 2006/42/CE;
comply with the essential safety requirements related to the products within the field of applicability of the Community Directives 2014/35/UE and 2014/30/UE

*sono costruiti per essere incorporati in una macchina o per essere assemblati con altri macchinari per costruire una macchina ai sensi della Direttiva 2006/42/CE;
sono conformi ai requisiti essenziali di sicurezza relativi ai prodotti entro il campo di applicabilità delle Direttive Comunitarie 2014/35/UE e 2014/30/UE*

THE MANUFACTURER OR THE AUTHORIZED REPRESENTATIVE
IL COSTRUTTORE O IL RAPPRESENTATE AUTORIZZATO

SEA S.P.A.
ZONA INDUSTRIALE SANT'ATTO
64100 - TERAMO - ITALY
+ 39 0 861 588341
www.seateam.com

PLACE AND DATE OF ISSUE
LUOGO E DATA DI EMISSIONE

TERAMO, 11/11/2021

L'Administratore
The Administrator
Ernio Di Saverio





Automatic Gate Openers

International registered trademark n. 804888

SEA S.p.A.

Zona Industriale Sant'Atto - 64100 - Teramo - ITALY

Tel. +39 0 861 588341 r.a. Fax +39 0 861 588344

www.seateam.com