



## CUBE READER

ANTI-VANDALISM ALUMINUM KEYPAD FOR ACCESS CONTROL MANAGEMENT  
CLAVIER EN ALUMINIUM ANTI-VANDALISME POUR GESTION CONTRÔLE D'ACCES  
TASTIERA ANTI-VANDALO IN ALLUMINIO PER GESTIONE CONTROLLO ACCESSI

TECHNICAL FEATURES	
DC input	12V - 24V
AC input	12V - 24V
Absorption in Stand-by	80 mA
Absorption (operation without lock)	110 mA
Working temperature	-20°C - +50°C
Reader frequency	125 KHz
Protection class	IP65
Dimension	119x76x21 mm

DONNEES TECHNIQUES	
DC input	12V - 24V
AC input	12V - 24V
Absorption in Stand-by	80 mA
Absorption (fonctionnement sans serrure)	110 mA
Température fonctionnement	-20°C - +50°C
Fréquence du lecteur	125 KHz
Degré de protection	IP65
Dimensions	119x76x21 mm

DATI TECNICI	
DC input	12V - 24V
AC input	12V - 24V
Assorbimento in Stand-by	80 mA
Assorbimento (funzionamento senza serratura)	110 mA
Temperatura di lavoro	-20°C - +50°C
Frequenza del lettore	125 KHz
Grado di protezione	IP65
Dimensioni	119x76x21 mm

QUICK START
<p><b>QUICK STORAGE OF A CODE IN AREA 1</b> <i>Example</i> Code 5678 in area 1 on location 001 Enter the sequence: 1234 1234 *9 02 001 5678</p> <p><b>QUICK STORAGE OF A CODE IN AREA 2</b> <i>Example</i> Code 7890 in area 2 on location 02 Enter the sequence: 1234 1234 *9 03 02 7890</p> <p><b>QUICK STORAGE OF A CARD IN AREA 1 ON LOCATION 002</b> Enter the sequence: 1234 1234 *9 01 001 002 Pass the card on the reader</p> <p><b>QUICK STORAGE OF 20 CARDS IN AREA 1 STARTING FROM LOCATION 010</b> Enter the sequence: 1234 1234 *9 01 010 020 Pass sequentially the 20 cards on the reader</p> <p><b>CANCELLATION OF ALL CODES</b> Enter the sequence: 1234 1234 *8 88</p>

DEMARRAGE RAPIDE
<p><b>MÉMORISATION RAPIDE D'UN CODE DANS LA ZONE 1</b> <i>Exemple:</i> Code 5678 dans la zone 1 à la location 001 Tapez la séquence: 1234 1234 *9 02 001 5678</p> <p><b>MÉMORISATION RAPIDE D'UN CODE DANS LA ZONE 2</b> <i>Exemple:</i> Code 7890 dans la zone 2 à la location 02 Tapez la séquence: 1234 1234 *9 03 02 7890</p> <p><b>MÉMORISATION RAPIDE D'UNE CARD DANS LA ZONE 1 À LA LOCATION 002</b> Tapez la séquence: 1234 1234 *9 01 001 002 Passer la carte sur le lecteur</p> <p><b>MÉMORISATION RAPIDE DE 20 CARDS DANS LA ZONE 1 À PARTIR DE LA LOCATION 010</b> Tapez la séquence: 1234 1234 *9 01 010 020 Passer en séquence les 20 cartes sur le lecteur</p> <p><b>EFFACER TOUS LES CODES</b> Tapez la séquence: 1234 1234 *8 88</p>

AVVIO RAPIDO
<p><b>MEMORIZZAZIONE RAPIDA DI UN CODICE NELL'AREA 1</b> <i>Esempio:</i> Codice 5678 nell'area 1, su locazione 001 Digitare la sequenza: 1234 1234 *9 02 001 5678</p> <p><b>MEMORIZZAZIONE RAPIDA DI UN CODICE NELL'AREA 2</b> <i>Esempio:</i> Codice 7890 nell'area 2, su locazione 02 Digitare la sequenza: 1234 1234 *9 03 02 7890</p> <p><b>MEMORIZZAZIONE RAPIDA DI UNA CARD NELL'AREA 1, SU LOCAZIONE 002</b> Digitare la sequenza: 1234 1234 *9 01 001 002 Passare la card sul lettore</p> <p><b>MEMORIZZAZIONE RAPIDA DI 20 CARDS NELL'AREA 1 A PARTIRE DALLA LOCAZIONE 010</b> Digitare la sequenza: 1234 1234 *9 01 010 020 Passare in sequenza le 20 cards sul lettore</p> <p><b>CANCELLAZIONE DI TUTTI I CODICI</b> Digitare la sequenza: 1234 1234 *8 88</p>

## INSTALLATION - INSTALLATION - INSTALLAZIONE

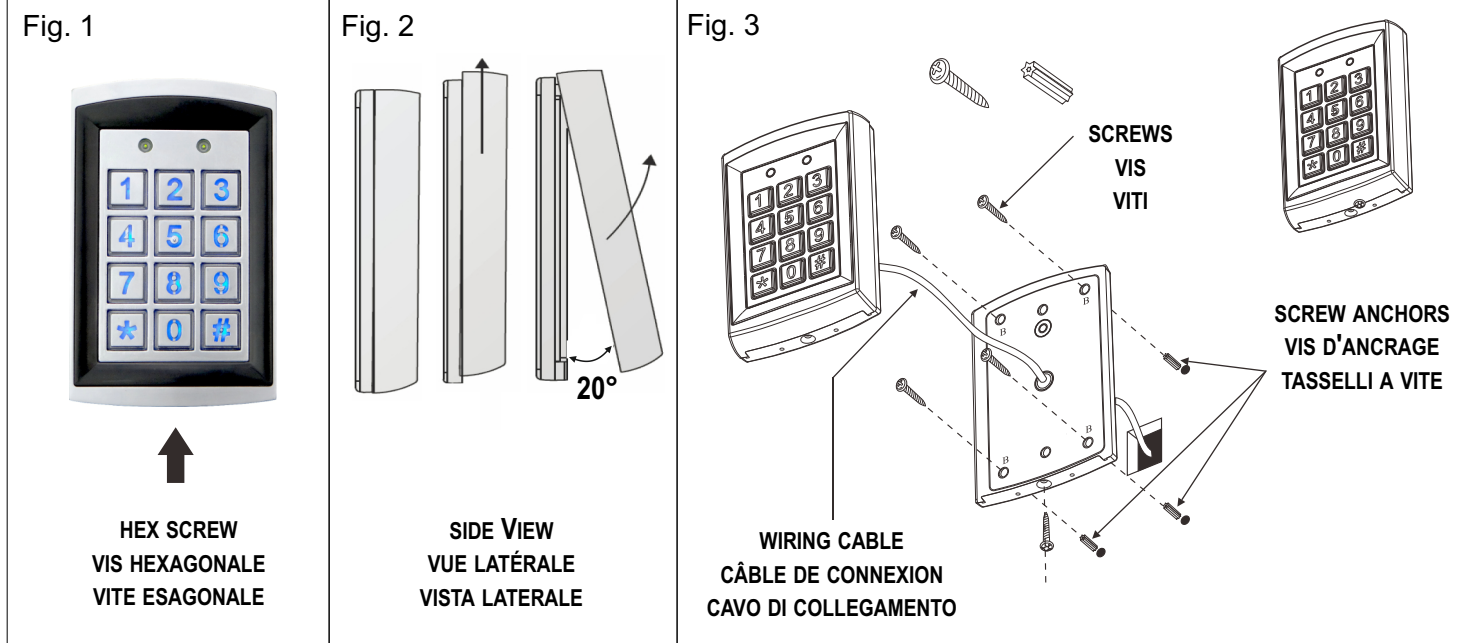

- Fig. 1 - Release hex screw from the bottom of the keypad.
- Fig. 2 - Press the keypad up to release it from the mounting plate.
- Fig. 3 - Thread the cable through the entry hole and make the system wirings (see wiring diagram);  
fix the mounting plate to the wall surface;  
slide the keypad on the mounting plate;  
re-fit the hex screw to secure the keypad

**NOTE: If using more than one keyboard, ensure they are mounted at least 185 cm apart**

- Fig. 1 - Desserrez la vis hexagonale du bas du clavier.
- Fig. 2 - Vue latérale - poussez le clavier vers l' haut pour le désengager de la plaque de montage.
- Fig. 3 - Faire passer le câble par le trou d'entrée et réaliser les câblages de l'installation (voir schéma) ;  
fixez la plaque de montage à la surface du mur ;  
faites glisser le clavier sur la plaque de montage ;  
remettez la vis hexagonale pour fixer le clavier

**REMARQUE : Si vous utilisez plusieurs claviers, assurez-vous qu'ils sont montés à au moins 185 cm l'un de l'autre**

- Fig. 1 - Svitare la vite esagonale dalla parte inferiore della tastiera.
- Fig. 2 - Premere la tastiera verso l'alto per sganciarla dalla piastra di montaggio.
- Fig. 3 - Far passare il cavo nel foro passacavo ed eseguire i cablaggi dell'impianto (vedi schemi);  
fissare la piastra di montaggio alla superficie della parete;  
far scorrere la tastiera sulla piastra di montaggio;  
rimontare la vite esagonale per fissare la tastiera

**NOTA: se si utilizza più di una tastiera, assicurarsi che siano montate a una distanza di almeno 185 cm l'una dall'altra**

## WIRING DIAGRAM - SCHEMA DE CÂBLAGE - SCHEMA ELETTRICO

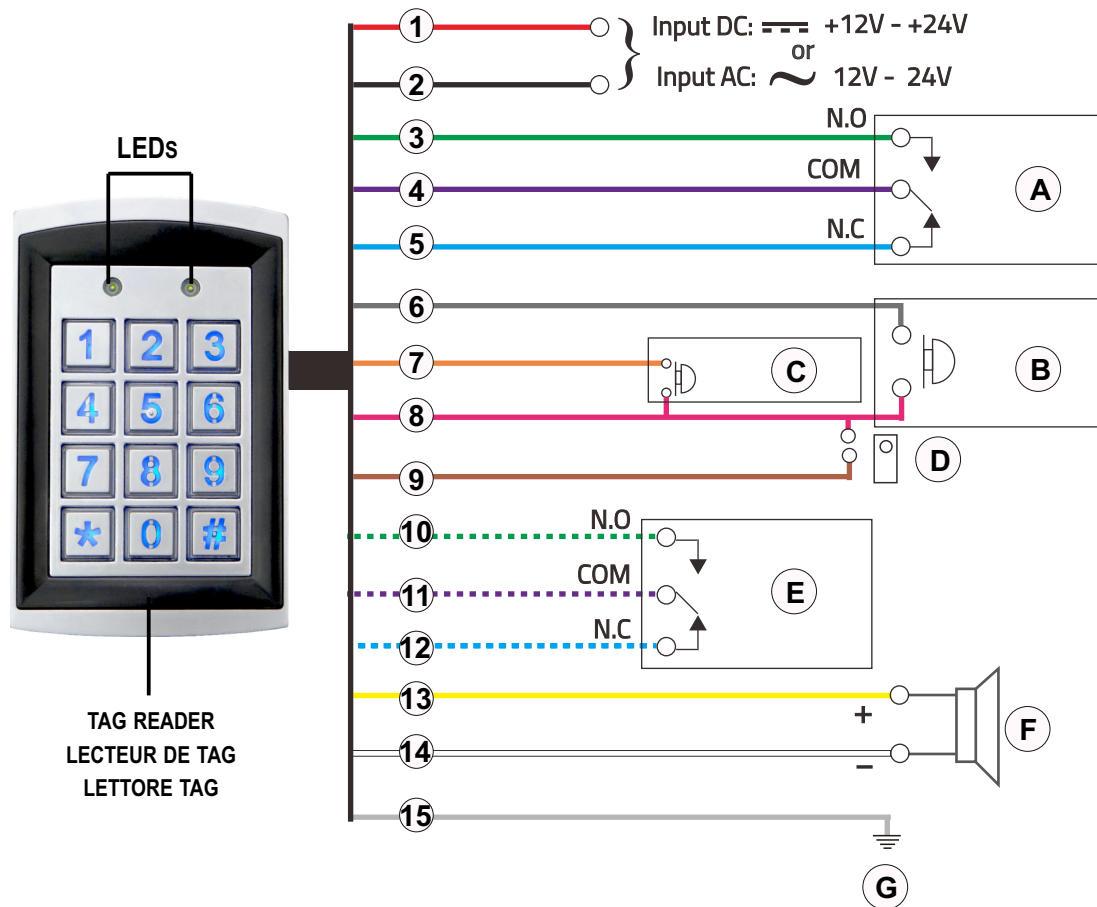



### CABLES - CÂBLES - CAVI

1	RED	ROUGE	ROSSO
2	BLACK	NOIR	NERO
3	GREEN	VERT	VERDE
4	PURPLE	VIOLET	VIOLA
5	BLUE	BLEU	BLU
6	GREY	GRIS	GRIGIO
7	ORANGE	ORANGE	ARANCIA
8	PINK	ROSE	ROSA
9	BROWN	BRUN	MARRONE
10	GREEN/WHITE	VERT/BLANC	VERDE/BIANCO
11	PURPLE/WHITE	VIOLET/BLANC	VIOLA/BIANCO
12	BLUE/WHITE	BLEU/BLANC	BLU/BIANCO
13	YELLOW	JAUNE	GIALLO
14	WHITE	BLANC	BIANCO
15	SILVER	ARGENT	ARGENTO

### WIRINGS - CONNEXIONS - COLLEGAMENTI



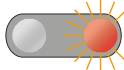
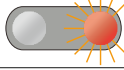

A	OUTPUT FOR RELAY 1 (VOLT-FREE)	SORTIE RELAY 1 (SANS VOLTAGE)	USCITA PER RELAY 1 (SENZA TENSIONE)
B	PUSH BUTTON FOR RELAY 1 (N.O.)	POUSOIR RELAY 1 (N.O.)	PULSANTE RELAY 1 (NO.)
C	PUSH BUTTON FOR RELAY 2 (N.O.)	POUSOIR RELAY 2 (N.O.)	PULSANTE RELAY 2 (NO.)
D	MAGNETIC DOOR LOCK	SERRURE MAGNÉTIQUE PORTE	SERRATURA MAGNETICA PORTA
E	OUTPUT FOR RELAY 2 (VOLT-FREE)	SORTIE RELAY 2 (SANS VOLTAGE)	USCITA PER RELAY 2 (SENZA TENSIONE)
F	SPEAKER CONNECTION FOR DOORBELL FACILITY 8 x 0.5 W RECOMMENDED	CONNEXION HAUT-PARLEUR POUR INSTALLATION SONNETTE 8 x 0.5 W RECOMMANDÉ	COLLEGAMENTO ALTOPARLANTE PER IMPIANTO CAMPANELLO 8 x 0,5 W CONSIGLIATO
G	SHIELD WIRE (COM OR GROUND)	CÂBLE BLINDE (COM OU TERRE)	CAVO SCHERMATO (COM O TERRA)

### DEFAULT PIN CHANGING - MODIFICATION DU PIN DE DEFAULT - MODIFICA PIN DI DEFAULT

STEP	ACTION	LED STATUS
1	<input type="text" value="1"/> <input type="text" value="2"/> <input type="text" value="3"/> <input type="text" value="4"/> <input type="text" value="1"/> <input type="text" value="2"/> <input type="text" value="3"/> <input type="text" value="4"/> DEFAULT	
2	<input type="text" value="*"/> <input type="text" value="3"/>	
3	<input type="text" value="?"/> <input type="text" value="?"/> <input type="text" value="?"/> <input type="text" value="?"/> * <del>NO!</del> <input type="text" value="1"/> <input type="text" value="2"/> <input type="text" value="3"/> <input type="text" value="4"/>	
4	<input type="text" value="?"/> <input type="text" value="?"/> <input type="text" value="?"/> <input type="text" value="?"/>	
5	<input type="text" value="#"/> <input type="text" value="#"/>	

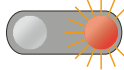





STEP	ACTION		
1	ENTER DEFAULT PIN - LONG TONE -	ENTREZ LE CODE PIN DE DÉFAUT - BIP LONG -	DIGITARE IL PIN DI DEFAULT - BIP LUNGO -
2	ENTER THE KEY	TAPEZ LES TOUCHES	DIGITARE I TASTI INDICATI
3	ENTER THE NEW FOUR DIGITS PIN	ENTREZ UN NOUVEAU PIN DE 4 CHIFFRES	DIGITARE UN NUOVO PIN DI 4 CIFRE
4	REPEAT THE NEW FOUR DIGITS PIN - LONG TONE -	ENTREZ ENCORE LE NOUVEAU PIN - BIP LONG -	DIGITARE ANCORA IL NUOVO PIN - BIP LUNGO -
5	END	FIN	FINE

### ACCESS CODE SETUP - CONFIGURATION CODE D'ACCESS - IMPOSTAZIONE CODICE DI ACCESSO

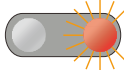
STEP	ACTION	LED STATUS
1	<input type="text" value="1"/> <input type="text" value="2"/> <input type="text" value="3"/> <input type="text" value="4"/> <input type="text" value="1"/> <input type="text" value="2"/> <input type="text" value="3"/> <input type="text" value="4"/> DEFAULT	
2	<input type="text" value="*"/> <input type="text" value="9"/>	
3	<input type="text" value="0"/> <input type="text" value="2"/>	
4	<input type="text" value="0"/> <input type="text" value="0"/> <input type="text" value="0"/> ~ <input type="text" value="9"/> <input type="text" value="9"/> <input type="text" value="9"/>	
5	<input type="text" value="?"/> <input type="text" value="?"/> <input type="text" value="?"/> <input type="text" value="?"/> * <del>NO!</del> <input type="text" value="1"/> <input type="text" value="2"/> <input type="text" value="3"/> <input type="text" value="4"/>	
6	<input type="text" value="#"/> <input type="text" value="#"/>	

STEP	ACTION		
1	ENTER DEFAULT PIN - LONG TONE -	ENTREZ LE CODE PIN DE DÉFAUT - BIP LONG -	DIGITARE IL PIN DI DEFAULT - BIP LUNGO -
2	ENTER THE KEY	TAPEZ LES TOUCHES	DIGITARE I TASTI INDICATI
3	ENTER THE KEY - LONG TONE -	TAPEZ LES TOUCHES - BIP LONG -	DIGITARE I TASTI INDICATI - BIP LUNGO -
4	ENTER A STARTING LOCATION NO. - DOUBLE TONE -	ENTREZ UN N° DE EMPLACEMENT INITIALE - DOUBLE BIP -	DIGITARE UN N° DI LOCAZIONE INIZIALE - BIP DOPPIO -
5	ENTER A FOUR DIGITS CODE (*) - LONG TONE -	ENTREZ UN CODE DE 4 CHIFFRES (*) - BIP LONG -	DIGITARE UN CODICE DI 4 CIFRE (*) - BIP LUNGO -
6	END	FIN	FINE

### TAGs BATCH SETUP - CONFIGURATION GROUPE TAGs - IMPOSTAZIONE GRUPPO TAGs







STEP	ACTION	LED STATUS
1	<input type="text" value="1"/> <input type="text" value="2"/> <input type="text" value="3"/> <input type="text" value="4"/> <input type="text" value="1"/> <input type="text" value="2"/> <input type="text" value="3"/> <input type="text" value="4"/> DEFAULT	
2	<input type="text" value="*"/> <input type="text" value="9"/>	
3	<input type="text" value="0"/> <input type="text" value="1"/>	
4	<input type="text" value="0"/> <input type="text" value="0"/> <input type="text" value="0"/> ~ <input type="text" value="9"/> <input type="text" value="9"/> <input type="text" value="9"/> *	
5	<input type="text" value="?"/> <input type="text" value="?"/> <input type="text" value="?"/> EXAMPLE: GROUP OF 27 TAGS → ENTER: 027	
6	 TAGS OR CARDS TYPE NORMAL EM 125 KHZ	
7	<input type="text" value="#"/> <input type="text" value="#"/>	

STEP	ACTION		
1	ENTER DEFAULT PIN - LONG TONE -	ENTREZ LE CODE PIN DE DÉFAUT - BIP LONG -	DIGITARE IL PIN DI DEFAULT - BIP LUNGO -
2	ENTER THE KEY	TAPEZ LES TOUCHES	DIGITARE I TASTI INDICATI
3	ENTER THE KEY - LONG TONE -	TAPEZ LES TOUCHES - BIP LONG -	DIGITARE I TASTI INDICATI - BIP LUNGO -
4	ENTER A STARTING UNUSED LOCATION N° - LONG TONE -	ENTREZ UN N° DE EMPLACEMENT INITIALE VIDE - BIP LONG -	DIGITARE UN N° DI LOCAZIONE INIZIALE VUOTA - BIP LUNGO -
5	ENTER THE NO. OF TAGS IN 3-DIGITS - TONE -	ENTREZ LE N° DE TAG EN 3 CHIFFRES - BIP -	DIGITARE N° DEI TAG IN 3 CIFRE - BIP -
6	PRESENT ALL THE TAGS - TONE -	PRESENTEZ TOUS LES TAGS - BIP -	PASSARE TUTTI I TAGS - BIP -
7	END	FIN	FINE

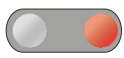
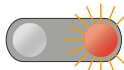
\* EACH TAG WILL USE A LOCATION NUMBER - CHAQUE TAG UTILISE UN NUMÉRO D'EMPLACEMENT - OGNI TAG UTILIZZA UN NUMERO DI LOCAZIONE



## TAGs BATCH SETUP - CONFIGURATION GROUPE TAGs - IMPOSTAZIONE GRUPPO TAGs

TAGs IN CONSECUTIVE NUMBERS- TAGs EN NOMBRES CONSECUTIFS - TAGs IN NUMERO CONSECUTIVO

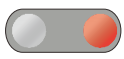
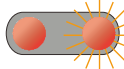
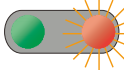

STEP	ACTION	LED STATUS	STEP	ACTION
1	<input type="text" value="1"/> <input type="text" value="2"/> <input type="text" value="3"/> <input type="text" value="4"/> <input type="text" value="1"/> <input type="text" value="2"/> <input type="text" value="3"/> <input type="text" value="4"/> DEFAULT		1	ENTER DEFAULT PIN - LONG TONE - ENTREZ LE CODE PIN DE DÉFAUT - BIP LONG - DIGITARE IL PIN DI DEFAULT - BIP LUNGO -
2	<input type="text" value="*"/> <input type="text" value="9"/>		2	ENTER THE KEY TAPEZ LES TOUCHES DIGITARE I TASTI INDICATI
3	<input type="text" value="0"/> <input type="text" value="5"/>		3	ENTER THE KEY - LONG TONE - TAPEZ LES TOUCHES - BIP LONG - DIGITARE I TASTI INDICATI - BIP LUNGO -
4	<input type="text" value="0"/> <input type="text" value="0"/> <input type="text" value="0"/> ~ <input type="text" value="9"/> <input type="text" value="9"/> <input type="text" value="9"/> *		4	ENTER AN UNUSED LOCATION NO. - LONG TONE - ENTREZ UN N° DE EMPLACEMENT VIDE - BIP LONG - DIGITARE UN N° DI LOCAZIONE VUOTA - BIP LUNGO -
5	<input type="text" value="?"/> <input type="text" value="?"/> <input type="text" value="?"/> EXAMPLE: GROUP OF 27 TAGS → ENTER: 027		5	ENTER THE NO. OF TAGS IN 3-DIGITS - TONE - ENTREZ LE N° DE TAG EN 3 CHIFFRES - BIP - DIGITARE N° DEI TAG IN 3 CIFRE - BIP -
6	 TAGS OR CARDS TYPE NORMAL EM 125 KHZ		6	PRESENT THE TAGS STARTING FROM THE LOWEST SERIAL NO. - TONE - PRÉSENTER LES TAGS COMMENÇANT PAR LE N° DE SÉRIE PLUS BAS - BIP - PASSARE I TAGS COMINCIANDO DAL N° DI SERIE PIU BASSO - BIP -
7	<input type="text" value="#"/> <input type="text" value="#"/>		7	END FIN FINE

\* EACH TAG WILL USE A LOCATION NUMBER - CHAQUE TAG UTILISE UN NUMÉRO D'EMPLACEMENT - OGNI TAG UTILIZZA UN NUMERO DI LOCAZIONE

## CODE (or TAGs) DELETING - CANCELLATION CODE (ou TAGs) - CANCELLAZIONE CODICE (o TAGs)



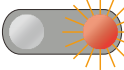

STEP	ACTION	LED STATUS	STEP	ACTION
1	<input type="text" value="1"/> <input type="text" value="2"/> <input type="text" value="3"/> <input type="text" value="4"/> <input type="text" value="1"/> <input type="text" value="2"/> <input type="text" value="3"/> <input type="text" value="4"/> DEFAULT		1	ENTER DEFAULT PIN - LONG TONE - ENTREZ LE CODE PIN DE DÉFAUT - BIP LONG - DIGITARE IL PIN DI DEFAULT - BIP LUNGO -
2	<input type="text" value="0"/> <input type="text" value="0"/> <input type="text" value="0"/> ~ <input type="text" value="9"/> <input type="text" value="9"/> <input type="text" value="9"/>		2	ENTER THE CODE (OR TAG) LOCATION NO. ENTREZ LE N° D'EMPLACEMENT DU CODE (OU TAG) DIGITARE IL N° DI LOCAZIONE DEL CODICE (O DEL TAG)
3	<input type="text" value="*"/> <input type="text" value="*"/>		3	ENTER THE KEY TO DELETE THE CODE (OR TAG) TAPEZ LES TOUCHES DE CANCELLATION DU CODE (OU TAG) DIGITARE I TASTI DI CANCELLAZIONE DEL CODICE (O TAG)
4	<input type="text" value="#"/> <input type="text" value="#"/>		4	END FIN FINE

## ALL CODES and TAGs CLEARING - CANCELLATION TOUS CODES et TAG - CANCELLAZIONE TUTTI CODICI e TAG

STEP	ACTION	LED STATUS	STEP	ACTION
1	<input type="text" value="1"/> <input type="text" value="2"/> <input type="text" value="3"/> <input type="text" value="4"/> <input type="text" value="1"/> <input type="text" value="2"/> <input type="text" value="3"/> <input type="text" value="4"/> DEFAULT		1	ENTER DEFAULT PIN - LONG TONE - ENTREZ LE CODE PIN DE DÉFAUT - BIP LONG - DIGITARE IL PIN DI DEFAULT - BIP LUNGO -
2	<input type="text" value="*"/> <input type="text" value="8"/>		2	ENTER THE KEY TAPEZ LES TOUCHES DIGITARE I TASTI INDICATI
3	<input type="text" value="8"/> <input type="text" value="8"/>		3	ENTER THE KEY TO CLEAR ALL - LONG TONE - TAPEZ LES TOUCHES DE CANCELLATION - BIP LONG - DIGITARE I TASTI DI CANCELLAZIONE - BIP LUNGO -
4	<input type="text" value="#"/> <input type="text" value="#"/>		4	END FIN FINE





**FORGOT THE PASSWORD? TURN OFF THE POWER, HOLD PRESSED  AND TURN ON THE POWER, WAIT FOR A DOUBLE BIP: PASSWORD RESETTED TO 1234**  
**MOT DE PASSE OUBLIÉ? COUPEZ L'ALIMENTATION, MAINTENEZ APPUYÉ  ET RALLUMEZ, ATTENDEZ UN DOUBLE BIP: MOT DE PASSE RÉINITIALISÉ À 1234**  
**PASSWORD DIMENTICATA? TOGLIERE ALIMENTAZIONE, MANTENERE PREMUTO  E RIACCENDERE, ATTENDERE DOPPIO BIP: PASSWORD REIMPOSTATA A 1234**

## RESET TO FACTORY SETTINGS - RETOUR AUX REGLAGES D'USINE - RIPRISTINO IMPOSTAZIONI DI FABBRICA

STEP	ACTION	LED STATUS
1	<input type="text" value="1"/> <input type="text" value="2"/> <input type="text" value="3"/> <input type="text" value="4"/> <input type="text" value="1"/> <input type="text" value="2"/> <input type="text" value="3"/> <input type="text" value="4"/> DEFAULT	
2	 <input type="text" value="8"/>	
3	<input type="text" value="9"/> <input type="text" value="9"/>	
4	<input type="text" value="#"/> <input type="text" value="#"/>	



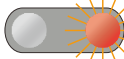

STEP	ACTION		
1	ENTER DEFAULT PIN - LONG TONE -	ENTREZ LE CODE PIN DE DÉFAUT - BIP LONG -	DIGITARE IL PIN DI DEFAULT - BIP LUNGO -
2	ENTER THE KEY	TAPEZ LES TOUCHES	DIGITARE I TASTI INDICATI
3	ENTER THE RESET KEY - LONG TONE -	TAPEZ LES TOUCHES DE CANCELLATION - BIP LONG -	DIGITARE I TASTI DI CANCELLAZIONE - BIP LUNGO -
4	END	FIN	FINE

## BACKLIGHT - RETROECLAIRAGE - RETROILLUMINAZIONE

STEP	ACTION	LED STATUS
1	<input type="text" value="1"/> <input type="text" value="2"/> <input type="text" value="3"/> <input type="text" value="4"/> <input type="text" value="1"/> <input type="text" value="2"/> <input type="text" value="3"/> <input type="text" value="4"/> DEFAULT	
2	 <input type="text" value="2"/>	
3	<input type="text" value="0"/> <input type="text" value="2"/> → TO ENABLE ACTIVER ATTIVARE <input type="text" value="0"/> <input type="text" value="1"/> → TO DISABLE DESACTIVER DISATTIVARE	
4	<input type="text" value="#"/> <input type="text" value="#"/>	





STEP	ACTION		
1	ENTER DEFAULT PIN - LONG TONE -	ENTREZ LE CODE PIN DE DÉFAUT - BIP LONG -	DIGITARE IL PIN DI DEFAULT - BIP LUNGO -
2	ENTER THE KEY	TAPEZ LES TOUCHES	DIGITARE I TASTI INDICATI
3	02 TO ENABLE 01 TO DISABLE - LONG TONE -	02 ACTIVATION 01 DÉSACTIVATION - BIP LONG -	02 PER ATTIVARE 01 PER DISATTIVARE - BIP LUNGO -
4	END	FIN	FINE

## BUZZER FUNCTION - FONCTION BUZZER - FUNZIONE BUZZER

STEP	ACTION	LED STATUS
1	<input type="text" value="1"/> <input type="text" value="2"/> <input type="text" value="3"/> <input type="text" value="4"/> <input type="text" value="1"/> <input type="text" value="2"/> <input type="text" value="3"/> <input type="text" value="4"/> DEFAULT	
2	 <input type="text" value="2"/>	
3	<input type="text" value="0"/> <input type="text" value="3"/> → TO ENABLE ACTIVER ATTIVARE <input type="text" value="0"/> <input type="text" value="4"/> → TO DISABLE DESACTIVER DISATTIVARE	
4	<input type="text" value="#"/> <input type="text" value="#"/>	

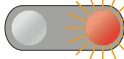

STEP	ACTION		
1	ENTER DEFAULT PIN - LONG TONE -	ENTREZ LE CODE PIN DE DÉFAUT - BIP LONG -	DIGITARE IL PIN DI DEFAULT - BIP LUNGO -
2	ENTER THE KEY	TAPEZ LES TOUCHES	DIGITARE I TASTI INDICATI
3	ENTER THE KEY: 03 TO ENABLE 04 TO DISABLE	TAPEZ: 03 ACTIVATION 04 DÉSACTIVATION	DIGITARE: 03 PER ATTIVARE 04 PER DISATTIVARE
4	END IF BUZZER IS DISABLED, THE KEYPAD OPERATION IS MUTE	FIN BUZZER DÉSACTIVÉ: FONCTIONNEMENT DU CLAVIER EST MUET	FINE BUZZER DISABILITATO: FUNZIONAMENTO DELLA TASTIERA È MUTO

## TAMPER ALARM - ALARME ANTI-SABOTAGE - ALLARME ANTI-MANOMISSIONE

STEP	ACTION	LED STATUS
1	<input type="text" value="1"/> <input type="text" value="2"/> <input type="text" value="3"/> <input type="text" value="4"/> <input type="text" value="1"/> <input type="text" value="2"/> <input type="text" value="3"/> <input type="text" value="4"/> DEFAULT	
2	 <input type="text" value="6"/>	
3	<input type="text" value="0"/> <input type="text" value="2"/> → TO ENABLE ACTIVER ATTIVARE <input type="text" value="0"/> <input type="text" value="1"/> → TO DISABLE DESACTIVER DISATTIVARE	
4	<input type="text" value="#"/> <input type="text" value="#"/>	

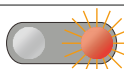

STEP	ACTION		
1	ENTER DEFAULT PIN - LONG TONE -	ENTREZ LE CODE PIN DE DÉFAUT - BIP LONG -	DIGITARE IL PIN DI DEFAULT - BIP LUNGO -
2	ENTER THE KEY	TAPEZ LES TOUCHES	DIGITARE I TASTI INDICATI
3	02 TO ENABLE 01 TO DISABLE - LONG TONE -	02 ACTIVATION 01 DÉSACTIVATION - BIP LONG -	02 PER ATTIVARE 01 PER DISATTIVARE - BIP LUNGO -
4	END TAMPER ALARM ACTIVATES THE INTERNAL BUZZER AND THE DOOR BELL CONTACT IF THE LIGHT SENSOR IS EXPOSED	FIN L'ALARME ANTI-SABOTAGE ACTIVE LE BUZZER INTERNE ET LE CONTACT SONNETTE SI LE CAPTEUR DE LUMIÈRE EST EXPOSÉ	FINE L'ALLARME TAMPER ATTIVA IL BUZZER INTERNO E IL CONTATTO CAMPANELLO SE IL SENSORE LUCE È ESPOSTO

### RELAY 1 TIME SETTING - RÉGLAGE DU TEMPS RELAY 1 - IMPOSTAZIONE TEMPO RELAY 1

STEP	ACTION	LED STATUS
1	1 2 3 4 1 2 3 4 DEFAULT	
2	* 1	
3	? ?	
4	# #	



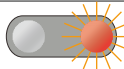

STEP	ACTION		
1	ENTER DEFAULT PIN - LONG TONE -	ENTREZ LE CODE PIN DE DÉFAUT - BIP LONG -	DIGITARE IL PIN DI DEFAULT - BIP LUNGO -
2	ENTER THE KEY	TAPEZ LES TOUCHES	DIGITARE I TASTI INDICATI
3	ENTER THE SECONDS: 00 - 99 - LONG TONE -	ENTREZ LES SECONDES: 00-99 - BIP LONG -	DIGITARE I SECONDI: 00 - 99 - BIP LUNGO -
4	END	FIN	FINE

### RELAY 2 TIME SETTING - RÉGLAGE DU TEMPS RELAY 2 - IMPOSTAZIONE TEMPO RELAY 2

STEP	ACTION	LED STATUS
1	1 2 3 4 1 2 3 4 DEFAULT	
2	* 5	
3	? ?	
4	# #	

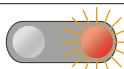

STEP	ACTION		
1	ENTER DEFAULT PIN - LONG TONE -	ENTREZ LE CODE PIN DE DÉFAUT - BIP LONG -	DIGITARE IL PIN DI DEFAULT - BIP LUNGO -
2	ENTER THE KEY	TAPEZ LES TOUCHES	DIGITARE I TASTI INDICATI
3	ENTER THE SECONDS: 00 - 99 - LONG TONE -	ENTREZ LES SECONDES: 00-99 - BIP LONG -	DIGITARE I SECONDI: 00 - 99 - BIP LUNGO -
4	END	FIN	FINE

### RELAY 2 CODE SETTING - CONFIGURATION CODE RELAY 2 - IMPOSTAZIONE CODICE RELAY 2

STEP	ACTION	LED STATUS
1	1 2 3 4 1 2 3 4 DEFAULT	
2	* 9	
3	0 3	
4	0 0 ~ 0 9	
5	? ? ? ? * <del>1 2 3 4</del> NO!	
6	# #	

STEP	ACTION		
1	ENTER DEFAULT PIN - LONG TONE -	ENTREZ LE CODE PIN DE DÉFAUT - BIP LONG -	DIGITARE IL PIN DI DEFAULT - BIP LUNGO -
2	ENTER THE KEY	TAPEZ LES TOUCHES	DIGITARE I TASTI INDICATI
3	ENTER THE KEY - LONG TONE -	TAPEZ LES TOUCHES - BIP LONG	DIGITARE I TASTI INDICATI - BIP LUNGO -
4	ENTER AN UNUSED LOCATION NO. - DOUBLE TONE -	ENTREZ UN N° DE EMPLACEMENT VIDE - DOUBLE BIP -	DIGITARE UN N° DI LOCAZIONE VUOTA - DOPPIO BIP -
5	ENTER A FOUR DIGITS CODE (*) - LONG TONE -	ENTREZ UN CODE DE 4 CHIFFRES (*) - BIP LONG -	DIGITARE UN CODICE DI 4 CIFRE (*) - BIP LUNGO -
6	END	FIN	FINE

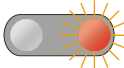
### RELAY 2 CODE DELETING - CANCELLATION CODE RELAY 2 - CANCELLAZIONE CODICE RELAY 2

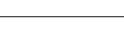
STEP	ACTION	LED STATUS
1	1 2 3 4 1 2 3 4 DEFAULT	
2	* 4	
3	0 0 ~ 0 9	
4	* *	
5	# #	

STEP	ACTION		
1	ENTER DEFAULT PIN - LONG TONE -	ENTREZ LE CODE PIN DE DÉFAUT - BIP LONG -	DIGITARE IL PIN DI DEFAULT - BIP LUNGO -
2	ENTER THE KEY	TAPEZ LES TOUCHES	DIGITARE I TASTI INDICATI
3	ENTER THE CODE LOCATION NO.	ENTREZ LE N° D'EMPLACEMENT DU CODE	DIGITARE IL N° DI LOCAZIONE DEL CODICE
4	ENTER THE KEY TO DELETE THE CODE	TAPEZ LES TOUCHES DE CANCELLATION DU CODE	DIGITARE I TASTI DI CANCELLAZIONE CODICE
5	END	FIN	FINE

